



PREFORMED LINE PRODUCTS

Section 16 – Preformed Access Solutions™ Products

Table of Contents	Page
COYOTE® Pre-Terminated Wall and Rack Mount Cabinets	16-2
COYOTE MPC Indoor/Outdoor Closure.....	16-3
COYOTE Passive Optical Components.....	16-6
COYOTE PLC Splitter Modules	16-8
COYOTE Fiber Wall Plate.....	16-9



COYOTE® Pre-Terminated Wall & Rack Mount Cabinets

COYOTE® Pre-Terminated Cabinets

Customized to meet your needs

Pre-Terminated cabinets not only saves time, they also save on installation labor costs. Fiber assemblies are 100% tested and labeled under ISO certified procedures. Units are ready for splicing right out of the carton.

All COYOTE fiber cabinets are made from rugged 16 gauge steel, protected with a durable powder-coat finish and accommodate standard COYOTE Splice Trays and Adapter Modules. Cabinets are available in two colors – almond or black.

Features & Benefits

- Craft-friendly COYOTE splice trays
- Integral fiber storage
- High-density splicing & patching in single cabinet
- Assembled to your exact specifications
- 100% tested & labeled
- UPC or APC fiber polishes
- Color coded pigtailed

Wall Mount Cabinets

The Wall Mount Cabinets provide protected fiber splicing and connectivity. A lockable inner door secures the splicing compartment. Each cabinet may be ordered empty or pre-terminated to your exact specification.

All cabinets include mounting hardware, tie-off brackets, grounding posts, grommets and hardware to secure splice trays.

Wall Mount Cabinets (Empty)				
Catalog Number	Description	Height (mm)	Width (mm)	Depth (mm)
WDC2_	Wall Mount Cabinet up to 24 Fiber Connections and Splices	10" (254)	13" (330)	3.5" (89)
WDC4_	Wall Mount Cabinet up to 48 Fiber Connections and Splices	14" (356)	13" (330)	3.5" (89)
WDC8_	Wall Mount Cabinet up to 96 Fiber Connections and Splices	17" (432)	13" (330)	5.5" (140)
WDC12_	Wall Mount Cabinet up to 144 Fiber Connections and Splices	12" (305)	17" (432)	11.0" (279)

Add "A" for Almond or "B" for Black to catalog number

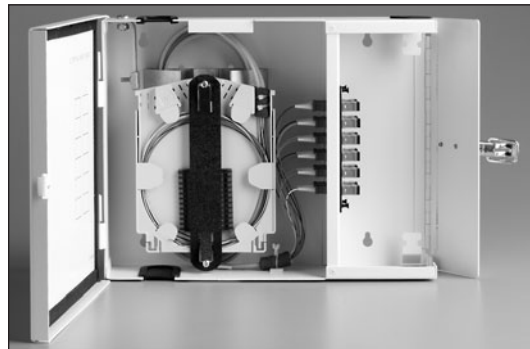

Pre-terminated Solution shown above
(See following pages to order your preterminated solutions)

Rack Mount Cabinets

Universal mounting brackets to fit 19" or 23" racks or enclosures are included. Clear front door and access panels are removable for easy entry. Each cabinet may be ordered empty or pre-terminated to your exact specifications.

All Rack Mount Cabinets have key hole slots for optional wall mounting.

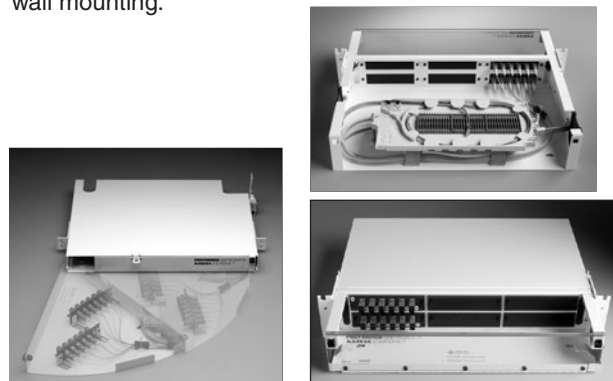

Rack Mount Cabinets (Empty)				
Catalog Number	Description	Rack Units	Width (mm)	Depth (mm)
RDC2_	Rack Mount Cabinet up to 12 Fiber Connections and Splices	1	17 (432)	14 (356)
RDC3_	Rack Mount Cabinet up to 36 Fiber Connections and Splices	2	17 (432)	14 (356)
RDC6_	Rack Mount Cabinet up to 72 Fiber Connections and Splices	2	17 (432)	14 (356)
RDC12_	Rack Mount Cabinet up to 144 Fiber Connections and Splices	3	17 (432)	14 (356)
RDC24_	Rack Mount Cabinet up to 288 Fiber Connections and splices	7	17 (432)	14 (356)

Add "A" for Almond or "B" for Black to catalog number

COYOTE® MPC Indoor/Outdoor Closure



COYOTE® MPC (Multi-Purpose Closure)

The COYOTE MPC is the latest product to the COYOTE Fiber Optics family to focus on the MDU environment. The new closure system provides a flexible platform to address the multitude of applications that exist in residential and commercial FTTx installations. The closure's styled exterior and neutral color allow it to blend with the surroundings but, good looks aren't everything, as the MPC is also highly functional.

The MPC is constructed of durable, UV stabilized, flame retardant (UL 94-5VA) polymer to permit interior or exterior applications. Eight cable entrance ports around the closure exterior accept an easy-to-use grommet system and standard commercially available fittings. The closure's interior can be configured to address slack storage, splicing, cross-connect, hardened adapter applications or any combination. Pre-terminated configurations are also available to minimize the amount of labor required during your installation.

The MPC is tested in accordance to elements of the Telcordia GR-771-CORE specification and offers NEMA4 performance. The MPC is manufactured in accordance with ISO 9001:2008 procedures to assure quality and is backed by the experience and field support that PLP has been noted for since 1947.

Features

- Size Standard: 16" L x 14" W x 4" D (41cm x 36cm x 10cm)
- Deep: 16" L x 14" W x 7" D (41cm x 36cm x 17.8cm)
- 8 Cable entrance ports around closure exterior
- Cable entrance ports are sized to accept PLP grommet adapter ports or commercially available fittings
- Easy to use grommet system – 7 different multi and single hole grommets to choose from
- Constructed with UL 94 5VA polymer compounds to provide the highest flame resistant rating
- Interior grid hole pattern allows custom organization to address your specific application
- Integrated rubber seal eliminates water entry
- Custom logo plaques available to identify your company logo – contact your PLP representative for further details

COYOTE MPC Kits	
Catalog Number	Description
COYMPC-000	COYOTE Standard MPC (Empty)
COYMPC-001	COYOTE MPC Standard – includes (1) 4 Hole Grommet Port Adapter Kit (8003812), (1) Organizer Clip Kit (8003813)
COYMPC-002	COYOTE MPC with OptiTap™ adapters – includes (1) 4 Hole Grommet Port Adapter Kit (8003812), (1) 8 Hole Grommet Port Adapter Kit (8003818), (1) bulkhead w/2 OptiTap Adapters, (1) Organizer Clip Kit (8003813), (1) Storage Bracket Kit (8003811), (1) Adapter Shroud
COYMPC-003	COYOTE MPC Standard w/Step Grommets – includes (1) Step Grommet Kit (80808618), (2) Organizer Clip Kits (8003813)
COYMPC-004	Standard MPC with Splice tray and grommets – includes (1) 4-hole Grommet Port Adapter Kit (8003828), (2) Organizer Clip Kits (8003813), (2) Cable Restraint Brackets (8003829), (2) Tray Brackets (80808689), and (1) Standard Splice Tray – 12 splice Count (80806033)
COYMPC-D000	COYOTE MPC Standard Deep-Empty
COYMPC-D001	COYOTE Deep MPC – includes (1) 4 Hole Grommet Port Adapter Kit (8003812), (1) Strength Member Bracket (8003829), and (2) Dual Organizer Clip Kits (8003870)

COYOTE MPC Accessories	
Catalog Number	Description
8003813	Organizer Clip Kit – contains 3 clips
8003811	Storage Bracket Kit – contains 2 brackets
8003879	Tray Bracket Kit for either Standard MPC or Deep MPC – contains (2) tray brackets, (2) studs, (1) hold down strap, (4) nylon cable clamps and (1) felt strap
8003814	MPC Splice Platform Kit for Single Fusion – includes 3 splice blocks
8003794	MPC Splice Platform Kit for Ribbon – includes 3 splice blocks
8003829	Cable Restraint Bracket Kit – includes 1 restraint bracket
80808467	Raceway Shroud Kit – includes 1 shroud
80808508	2 Port Internal OptiTap Bracket Kit – includes adapters
8003824	8 Port Internal OptiTap Bracket Kit – does not include adapters
LGSBS8-5	LITE-GRIP® Splice Block Kit for Single Fusion – accepts 8 splice protectors per block – 5 pcs per kit
LGSBR3-5	LITE-GRIP Splice Block Kit for Ribbon (Mass Fusion) – accepts 3 mass fusion protectors per block – 5 pcs per kit



COYOTE[®] MPC Indoor/Outdoor Closure

PLP Fiber Optic Products – COYOTE[®] MPC (Multi-Purpose Closure)

COYOTE Silicone Grommet Kits			
Catalog Number	Cable Range	Description	Grommets
8003825	.825" - 1" (21mm-25mm)	1 Hole Grommet Port Adapter Kit	
8003826	.60" - .825" (15mm-21mm)	1 Hole Grommet Port Adapter Kit	
8003827	.40" - .60" (10mm-15mm)	1 Hole Grommet Port Adapter Kit	
8003828	.275" - .500" (7mm-12mm)	2 Hole Grommet Port Adapter Kit	
8003812	.120" - .275" (3mm-7mm)	4 Hole Grommet Port Adapter Kit	
8003818	.120" - .200" (3mm-5mm)	8 Hole Grommet Port Adapter Kit	
80808618	.070" - 1.00" (1.8mm-25mm)	Stepped Grommet Kit	

Standard and Deep MPC Splice Tray Kit Options					
Standard MPC	Deep MPC	Standard MPC	Deep MPC	Standard MPC	Deep MPC
	Low Profile Tray (12 splice count) Cat. #80807701 (w/splice blocks) or #8001130 (blank)		Standard Tray (12 splice count) Cat. #80806033 (w/splice block) or #80806182 (blank)		LITE-GRIP [®] Short Tray ¹ (40 splice count) Cat. #LGSTS16 (single fusion)
4 Trays 48 Max Splice Count	12 Trays 144 Max Splice Count	3 Trays 36 Max Splice Count	8 Trays 96 Max Splice Count	2 Trays 288 Max Splice Count	6 Trays 240 Max Splice Count
	24 Count Low Profile Tray (24 splice count) Cat. #8003468 (w/splice blocks)		Ribbon Tray (72 splice count) Cat. # 80807114 (w/splice block) or 80808160 (blank)		LITE-GRIP [®] Short Tray (144 splice count) Cat. #LGSTR144 (mass fusion/ribbon)
4 Trays 96 Max Splice Count	12 Trays 288 Max Splice Count	2 Trays 144 Max Splice Count	6 Trays 432 Max Splice Count	2 Trays 288 Max Splice Count	6 Trays 864 Max Splice Count

¹Each tray (Cat. # LGSTS16) is provided with splice blocks to support 16 single fusion splices. Splice Block Kit (Cat. # LGSBS8-5) is required for each tray to achieve maximum splice count.

COYOTE® MPC Indoor/Outdoor Closure

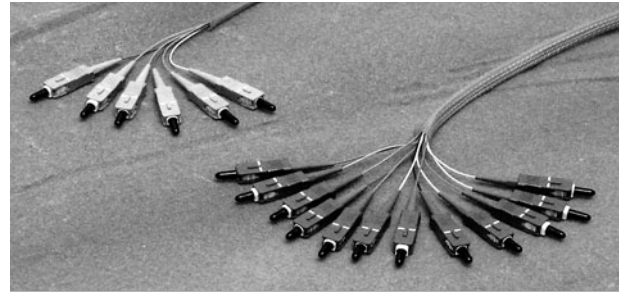
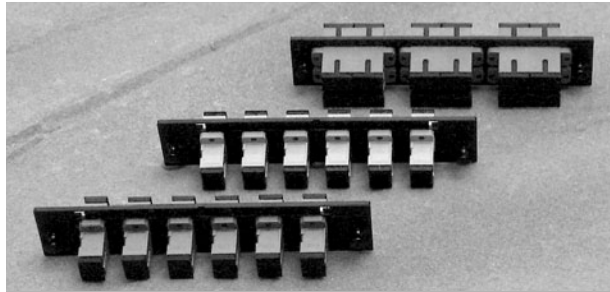

COYOTE® MPC (Multi-Purpose Closure)

Adapter Modules

Modular Plates fit any COYOTE cabinet and offer the ultimate in design flexibility.

- 6-port, 8-port and 12-port snap-in Adapter Plates
- Precision ceramic alignment sleeves

Pigtail Cable Assemblies

- Six or twelve color-coded 900 Micron SM fiber bundles, in yellow braided sleeve
- Ribbon fan outs
- Jacketed cable stubs also available

Adapter Modules			
Catalog Number	Connector	Adapters	Sleeve
6SMSC	SC	6	Ceramic
6SCAPC	SC/APC	6	Ceramic
12SMDC	SC	12 (6 Duplex)	Ceramic
8SMSC	SC	8	Ceramic
6SMST	ST	6	Ceramic
8SMST	ST	8	Ceramic
6SMFC	FC	6	Ceramic
8SMFC	FC	8	Ceramic
6FCAPC	FC/APC	6	Ceramic
6SMLC	LC	6	Ceramic
12SMLC	LC	12 (6 Duplex)	Ceramic
600	Blank Plate	–	–

Pigtail Cable Assemblies – Bundled 900 Micron Fibers in Yellow Sleeve		
Catalog Number	Connector	Fiber Count
P6SCU_*	SC/UPC	6
P12SCU_*	SC/UPC	12
P6SCA_*	SC/APC	6
P12SCA_*	SC/APC	12
P6ST_*	ST	6
P12ST_*	ST	12
P6FC_*	FC	6
P12FC_*	FC	12
P6LC_*	LC	6
P12LC_*	LC	12

*Cable length in meters
Contact PLP for additional options

Use the following approach to define the part number required for your COYOTE MPC Pre-Terminated Cabinet.

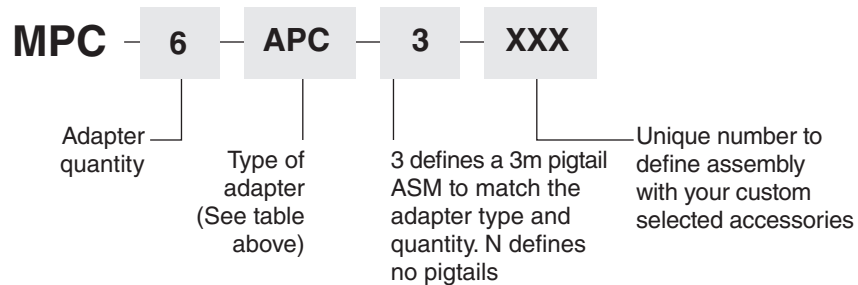

Contact PLP to determine if a specification has already been defined for your configuration prior to placing your order.



COYOTE® Passive Optical Components

Adapter Modules

Modular Plates fit any COYOTE cabinet and offer the ultimate in design flexibility.

6-port, 8-port and 12-port snap-in Adapter Plates come pre-loaded and ready for installation into COYOTE Fiber Cabinets. All adapter styles (ST, SC, FC, and LC) feature precision ceramic alignment sleeves.

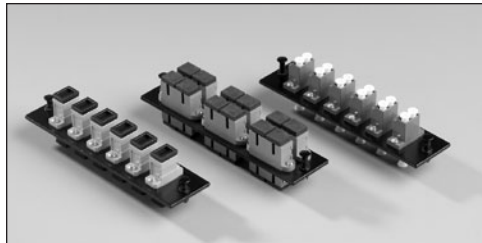

Adapter Modules			
Catalog Number	Connector	Adapters	Sleeve
6SMSC	SC	6	Ceramic
6SCAPC	SC/APC	6	Ceramic
12SMDC	SC	12 (6 Duplex)	Ceramic
8SMSC	SC	8	Ceramic
6SMST	ST	6	Ceramic
8SMST	ST	8	Ceramic
6SMFC	FC	6	Ceramic
8SMFC	FC	8	Ceramic
6FCAPC	FC/APC	6	Ceramic
6SMLC	LC	6 (3 Duplex)	Ceramic
12SMLC	LC	12 (6 Duplex)	Ceramic
600	Blank Plate	–	–

Pigtail Cable Assemblies

Six or twelve fiber color-coded 900 Micron SM bundles, in yellow braided sleeve. Ribbon fan outs and jacketed cable stubs also available. Contact PLP for additional options.

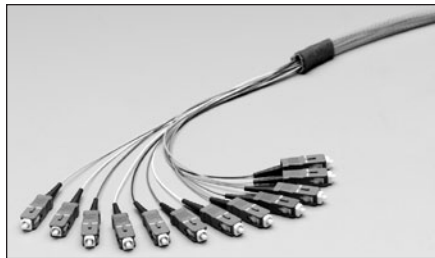

Pigtail Cable Assemblies Bundled 900 Micron Fibers in Yellow Sleeve		
Catalog Number	Connector	Fiber Count
P6SCU_*	SC/UPC	6
P12SCU_*	SC/UPC	12
P6SCA_*	SC/APC	6
P12SCA_*	SC/APC	12
P6ST_*	ST	6
P12ST_*	ST	12
P6FC_*	FC	6
P12FC_*	FC	12
P6LC_*	LC	6
P12LC_*	LC	12

*Add cable length (in meters) to catalog number. Three meters standard. Contact PLP for other options

Factory Polishes		
	Return Loss	Insertion Loss
UPC	-55 dB min.	0.2 typ 0.3 max
APC	-65 dB min.	0.3 max

Jumper Cable Assemblies

High Performance Singlemode Fiber Optic Jumpers feature UPC and APC terminations to handle the most demanding transmission speeds. Each jumper is 100% tested, for insertion and return loss and visually inspected.

2 mm or 3 mm Jacketed Cables available.



Jumper Cable Assemblies – 3 mm Jacketed	
Catalog Number	Connector
JSCU_*	SC/UPC
JSCA_*	SC/APC
JST_*	ST
JFC_*	FC
JLC_*	LC

*Add cable length (in meters) to catalog number. Contact PLP for other options

COYOTE® Passive Optical Components

COYOTE Splice Trays

User friendly splice trays for all applications

Five types of standard splice trays are available, four for single fiber splices and one for mass fiber splices.

These injection-molded trays have hinged, clear plastic covers for maximum fiber protection that allows for visible inspection of the fibers.

A series of tabs along the tray perimeter are easily removed to simplify routing of the fiber. When replaced, they retain the fiber.

COYOTE Splice Trays for single and mass fiber.



COYOTE Splice Trays	
Catalog Number	Description
80807701	12 Count Low Profile Tray w/plastic splice block – single fusion splices
80806033	12 Count Standard Tray w/elastomeric splice block – Fusion & mechanical splices
8001127	36 Count Low Profile Tray w/plastic splice block – single fusion splices
80807769	Blank Low Profile Splice Tray
80805514	36 Count Standard Tray w/elastomeric splice blocks – Fusion & mechanical splices
80805515	144 Count Ribbon Tray w/2 elastomeric splice blocks

*To increase splicing capacity by 50% – replace (2) Standard trays with (3) Low Profile trays.

Pre-terminated Cabinets

Ordering is as easy as 1-2-3!

When ordering standard COYOTE Pre-terminated Cabinets follow these easy steps

1. Select the type of cabinet, and color

Example; RDC24A __ __

Almond Rack Mount Cabinet with 24 slots for up to 288 connections (24 x 12)

2. Select number of fiber adapters or ports

Example; RDC24A96 __

Loaded with 96 adapters (standard 6 pack modules)

3. Select fiber connector style and length of pigtails

Example; RDC24A96SCU3

SMSC UPC polish 3 meter length Pigtails

Contact a PLP sales representative for assistance with other pre-terminated cabinet options.



COYOTE® PLC Splitter Modules

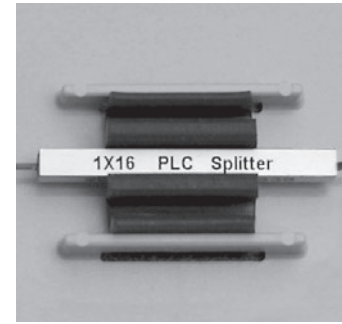
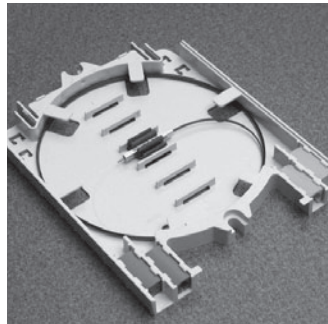

The Splitter Modules utilize PLC chips manufactured with Plasma Chemical Vapor Deposition (P-CVD) technology, and its patented fabrication process for providing stable optical specifications. The Modules' silica on silica waveguide and optical fiber array are tested to Telcordia GR-1209 and GR-1221. The splitters are designed to have low insertion loss, low polarization dependent loss (PDL), and high port uniformity.

Features

- 1 x 4, 1 x 8, 1 x 16, 1 x 32, and 1 x 64 configurations available
- Telcordia GR-1209 and GR-1221 qualified
- Low Insertion Loss, PDL, High Return Loss
- High output uniformity
- Compact package

Splitter Part No.	Splitter Ratio	Use with Splice Tray Kit Part No.
800012235	1 x 4	80808524, 80808525, 80806033, 80805514
800012236	1 x 8	80808524, 80808525, 80806033, 80805514
800012237	1 x 16	80808524, 80808525, 80805514
800012238	1 x 32	80808524, 80808525, 80805514

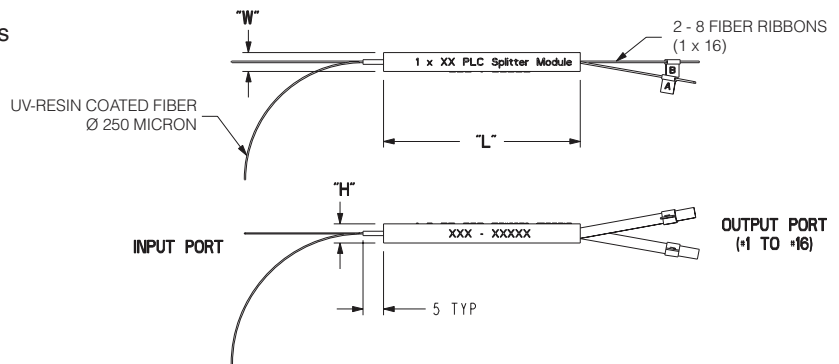

PLC Splitter Specifications	Units	1 x 4	1 x 8	1 x 16	1 x 32
Operating Wavelength	nm	1260 – 1650	1260 – 1650	1260 – 1650	1260 – 1650
Insertion Loss Max.	dB	7.2 ¹	10.5 ¹	13.5 ¹	16.5 ¹
		Max. 8.0 ² Typ. 7.7 ²	Max. 11.5 ² Typ. 11.0 ²	Max. 14.5 ² Typ. 14.2 ²	Max. 17.5 ² Typ. 17.2 ²
Uniformity Max.	dB	0.6 ¹	0.8 ¹	1.2 ¹	1.7 ¹
PDL Max.	dB	0.2 ¹	0.3 ¹	0.3 ¹	0.3 ¹
Return Loss Min.	dB	55.0 ¹	55.0 ¹	55.0 ¹	55.0 ¹
Directivity Min.	dB	55.0	55.0	55.0	55.0
Operating Temperature	°C	-40 to +85	-40 to +85	-40 to +85	-40 to +85
Pigtails	m	1 (Standard) or Custom Length Available (Input / 250 Micron, Output / Ribbon fiber)			
Dimensions (L x W x H)	mm	40 x 4 x 4	40 x 4 x 4	40 x 4 x 4	50 x 7 x 4

¹Excluding WDL, TDL (Wavelength Dependant Loss, Temperature Dependant Loss) Measured at room temp., 1310nm and 1550nm.

²Including WDL, TDL.

1 x 2 FBT Splitters and 1x64 PLC Splitter Modules are available upon request.

COYOTE® Fiber Wall Plate



The COYOTE Fiber Wall Plate is a compact fiber organizer used to create a fiber demarcation point inside the home, office or apartment. The internal fiber routing feature maintains bend radius control, allows for slack storage outside of the wall cavity and provides a maximum storage capacity of 5 ft. (152 cm) of 2 mm jacketed fiber or 3 ft. of 3 mm jacketed fiber. Each kit is provided with a factory installed SC/APC adapter. The design is easy to install and is capable of being mounted directly to standard electrical junction boxes or directly to wall.

- Compact Size: 4" W x 6" L x 1" D (10.2 cm x 15.2 cm x 2.5 cm)
- Available colors: white and almond
- Includes SC/APC adapter mounted inside
- Includes mounting fasteners and wall anchors
- Mounts to standard electrical junction boxes or walls
- Internal fiber routing features provide bend radius control
- Maximum internal slack storage of 5 ft. (152cm)
- Hinged door provides open access for easy fiber connection or removal
- Interlocking hinged doors automatically block view of internal adapter when the external fiber jumper is removed



Interior routing



Open access to fiber connection



Hinged interlocking doors

Catalog Number	Color	Description
8006992 W	White	COYOTE Fiber Wall Plate, includes (1) SC/APC adapter factory installed (1) mounting hardware kit
8006992 IV	Almond	COYOTE Fiber Wall Plate, includes (1) SC/APC adapter factory installed (1) mounting hardware kit
80061045	White	COYOTE Fiber Wall Plate Splice/Storage