



## **PREFORMED** LINE PRODUCTS

### **Section 10 – ARMADILLO® Stainless Series**

Table of Contents	Page
<b>Series Overview.....</b>	<b>10-2</b>
<b>ARMADILLO Selection Guide.....</b>	<b>10-4</b>
<b>ARMADILLO Stainless Shell Kits.....</b>	<b>10-5</b>
<b>ARMADILLO Sealing Washer End Plates.....</b>	<b>10-6</b>
<b>ARMADILLO Drillable End Plate Kits.....</b>	<b>10-7</b>
<b>ARMADILLO Stainless Kits .....</b>	<b>10-9</b>
<b>ARMADILLO Series Accessories .....</b>	<b>10-10</b>
<b>ARMADILLO Series Installation Materials/Spare Parts.....</b>	<b>10-12</b>
<b>ARMADILLO Bolt and Torque Bars .....</b>	<b>10-14</b>
<b>ARMADILLO Tools .....</b>	<b>10-15</b>
<b>ARMADILLO Stainless with Fire Retardant Drilled End Plates.....</b>	<b>10-17</b>
<b>ARMADILLO Stainless for Vault Applications.....</b>	<b>10-19</b>
<b>RD™ Encapsulant/Resin Kits for Buried Applications .....</b>	<b>10-21</b>
<b>Spacer Mat/Re-Encapsulation Kits for Buried Applications .....</b>	<b>10-22</b>



# ARMADILLO® Overview



**Born Tough...  
Bred Smart  
Tames Costs as Well as Nature**



## **ARMADILLO Stainless:**

For over 30 years, our Stainless Steel Splice Case has been the industry standard, with millions of successful applications around the world, protecting communications cables under even the most severe conditions. The PREFORMED Stainless Steel Splice Case is now the ARMADILLO Stainless. It is our premium series for the most demanding applications that is designed to offer superior performance and versatility for virtually any application.

### **The ARMADILLO Stainless is your best choice when...**

- Stainless steel is required for more demanding applications.
- Fire retardant stainless is required for vault applications.
- Exceeding Bell System standards may be necessary.
- Maintaining 15 psi (103kPA) is required (when used with drillable End Plates).

### **Design Features:**

- Re-usable
- Re-enterable
- Craft-friendly
- Re-entry kits not required
- Utilize torque bar for end plate positioning
- Accepts both end plate designs
- Used in underground, aerial or buried applications
- Feature captive hardware
- Made of corrosion resistant materials
- Utilize ARMADILLO Coupling for expanding cable opening

# ARMADILLO® Overview & Capacities



## A Whole New Species for Copper Cable



### ARMADILLO Sealing Washer End Plates:

With the introduction of the ARMADILLO Series comes a new end plate design. The ARMADILLO Sealing Washer End Plates eliminate major tooling costs, field drilling and does not require extensive training.

#### The ARMADILLO Sealing Washer End Plate is your best choice when...

- Your application does not require more than one, two or three cable entry ports.
- No power source for field drilling is available.
- Mastic sealing tapes are used that do not require C-Cement making these End Plates re-usable.

### ARMADILLO Drillable End Plates:

The ARMADILLO Series features a compatibility that includes the field proven Drillable End Plate. This end plate system can accommodate a variety of cables, cable sizes and cable configurations with either a two-section or a three-section end plate design.

#### The ARMADILLO Drillable End Plate is your best choice when...

- Field flexibility to custom drill the end plates on the job site is necessary and a power source is available.
- You have a demanding application that requires the LOCK-TAPE™ Sealing System providing exceptional pull-out strength.
- You have vault applications.

### Design Features:

These new end plates have no external fasteners, utilize the proven PREFORMED™ Torque Bar for positioning, and have universal inserts that enable grounding connections and air pressurization through the end plate. They also feature a unique strengthened, two-piece sealing washer that is available in the same sizes as competitive units and is interchangeable.

### Interchangeable and Compatible:

Both ARMADILLO End Plate styles are available in two and three section designs for use with 4", 6.5", 8.0", 9.5" and 12.5" (drillable only) diameter shell kits. They are compatible for use with the ARMADILLO Stainless shells. They will also accept a hybrid application utilizing both End Plate styles in the same closure.

### Design Features:

ARMADILLO Drillable End Plates can be field configured to meet your application requirements. Less stock is required with this design, because any bond connector can be used, and fixed sheath opening dimensions do not depend on bond connector placement. They are available with grounding and air valve inserts for air pressurization, aerial support and grounding through the end plate.

### End Plate Similarities:

- No exposed fastener hardware
- Grounding through end plate
- Torque bar used for positioning
- Craft-friendly



# ARMADILLO® Selection Guide

**Just follow these simple steps:**

### STEP ONE

Use this table to select the size of our ARMADILLO Stainless required based on the pair count.

ARMADILLO Stainless Capacities	
Pair Count of Cables	ARMADILLO Stainless Size (mm)
50 thru 300	4" x 25" (102 x 635)
300 thru 600	6.5" x 22" (165 x 559)
300 thru 1100	6.5" x 28" (165 x 711)
900 thru 1500	6.5" x 38" (165 x 965)
900 thru 2100	8" x 28" (203 x 711)
1200 thru 2400	8" x 38" (203 x 965)
1500 thru 2700	8" x 45" (203 x 1143)
1500 thru 2700	9.5" x 28" (241 x 711)
1800 thru 3600	9.5" x 38" (241 x 965)
2100 thru 4200	9.5" x 45" (241 x 1143)
2100 thru 4200	9.5" x 53" *(241 x 1356)
2400 thru 3000	12.5" x 28" (318 x 711)
2700 thru 3600	12.5" x 38" (318 x 965)
3000 thru 4200	12.5" x 45" (318 x 1143)
3000 thru 4800	12.5" x 65" *(318 x 1651)

**NOTE:** Capacities based on 24 gauge wire and industry standard splice modules.

\*Shells are welded

### STEP TWO

Choose from one of the ARMADILLO Stainless Kits with drilled end plates or the ARMADILLO Stainless Filling Flange Kits with drilled end plates.

These are the original PREFORMED™ Splice Case Kits and PREFORMED Splice Case with Filling Flange Kits that you are familiar with.

### STEP THREE

Select and order the individual components you need.

All components are interchangeable. You can have a closure with a Sealing Washer End Plate on one end and a Drilled End Plate on the other.

# ARMADILLO® Stainless Shell Kits

## ARMADILLO Stainless Shell Kits

ARMADILLO Stainless shells are precision-formed of stainless steel with an inside liner of neoprene. They feature a permanent gasket-sealing system that requires no re-entry kit or cleaning upon re-entry, and an integral air flange and grounding lead that allow pressurization and grounding through the shell. The LOCKBAR™ Fastening system features corrosion-resistant stainless steel front and back bars that mate through the flange area and lock into position to reduce installation time.

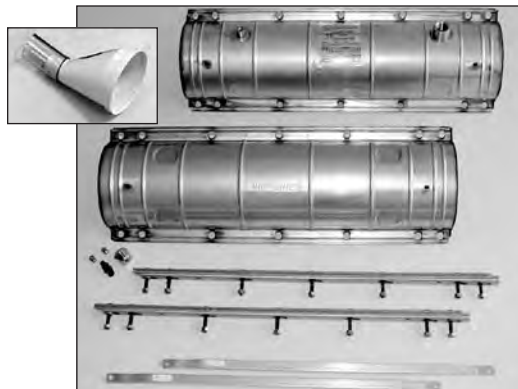

Standard Shell Kit

Stainless Shell Kit							
Size (mm)	Catalog Number		Dimensions (mm)			Sheath Opening	Shipping Weight (kg)
	Standard	Filling Flange	A	B	C		
4.0" x 25" (102 x 635)	8006750	8006756	25.8 (655)	4.5 (114)	6.0 (152)	16.8 (427)	12# (5)
6.5" x 22" (165 x 559)	8006510	8006390	22.0 (559)	7.0 (178)	9.3 (235)	12.7 (322)	15# (7)
6.5" x 28" (165 x 711)	8006474	8006244	28.4 (721)	7.0 (178)	9.3 (235)	19.2 (488)	26# (12)
6.5" x 38" (165 x 965)	8006751	8006246	38.4 (975)	7.0 (178)	9.3 (235)	29.2 (742)	33# (15)
8.0" x 28" (203 x 711)	8006776	8006391	28.4 (721)	8.5 (216)	10.5 (267)	19.2 (488)	24# (11)
8.0" x 38" (203 x 965)	8006777	8006392	38.4 (975)	8.5 (216)	10.5 (267)	29.2 (742)	35# (16)
8.0" x 45" (203 x 1143)	8006778	8006393	45.2 (1148)	8.5 (216)	10.5 (267)	36.2 (919)	57# (26)
9.5" x 28" (241 x 711)	8006779	8006245	28.4 (721)	10.0 (254)	12.5 (318)	18.1 (460)	32# (15)
9.5" x 38" (241 x 965)	8006780	8006247	38.4 (975)	10.0 (254)	12.5 (318)	28.1 (714)	40# (18)
9.5" x 45" (241 x 1143)	8006781	8006250	45.2 (1148)	10.0 (254)	12.5 (318)	36.2 (919)	52# (24)
9.5" x 53" (241 x 1346)	8003461	8006758	53.3 (1354)	10.0 (254)	12.5 (318)	43.2 (1097)	56# (25)
12.5" x 28" (318 x 711)	8006782	8006274	28.4 (721)	13.0 (330)	15.5 (394)	18.1 (460)	41# (19)
12.5" x 38" (318 x 965)	8006783	8006275	38.4 (975)	13.0 (330)	15.5 (394)	28.1 (714)	51# (23)
12.5" x 45" (318 x 1143)	8006784	8006276	45.2 (1148)	13.0 (330)	15.5 (394)	36.2 (919)	60# (27)
12.5" x 65" (318 x 1651)	8006509	n/a	65.0 (1651)	13.0 (330)	15.5 (394)	54.9 (1394)	146# (66)

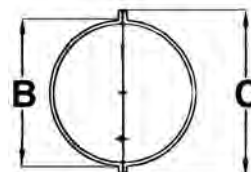
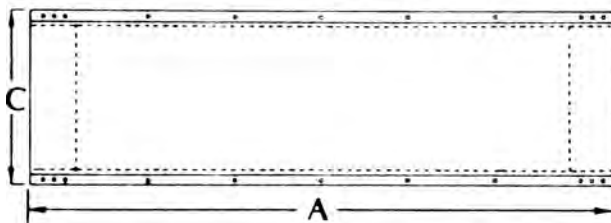



# ARMADILLO® Sealing Washer End Plates

## ARMADILLO Sealing Washer End Plates

With the introduction of the ARMADILLO Series comes a new end plate design. The ARMADILLO Sealing Washer End Plate eliminates major tooling costs, field drilling and extensive personnel training.

The ARMADILLO Sealing Washer End Plate does not have any exposed fastener hardware, offers grounding through the end plate and utilizes the torque bar for end plate positioning.

When selecting an end plate, the ARMADILLO Sealing Washer End Plate may be used for most OSP applications that do not require more than one, two or three cable entry ports. End plates feature a fixed number of entry ports that do not require a power source or major tooling for field drilling and are designed to maintain 10 psi. This design also utilizes Mastic sealing tapes that do not require the use of C-Cement and allow the end plates to be re-used.



ARMADILLO Sealing Washer End Plates

### Design Features:

The ARMADILLO Sealing Washer End Plates incorporate universal inserts that allow grounding connections and air pressurization through the end plate. In addition, this design includes a cable entry plug spool for plugging unused ports while allowing for future use. ARMADILLO Sealing Washer End Plates also feature a two-piece sealing washer that is stronger and eliminates the seam on sealing washers. These sealing washers are available in the same diameters as competitive units and may be cut on the job site with our easy and safe washer cutter tool or they may be cut with competitive cutters.

### Interchangeable and Compatible:

ARMADILLO Sealing Washer End Plates are available in one to three cable entry port designs for use with 4" (102 mm), 6.5" (165 mm), and 9.5" (241mm) diameter shell kits.

ARMADILLO Sealing Washer End Plate Kits			
Catalog Number	Size (mm)	Ports	Shipping Wt (kg)
8003514	4.0" (102)	2-Port	4# (2)
8003515	6.5" (165)	1-Port	4# (2)
8003516	6.5" (165)	2-Port	4# (2)
8003517	6.5" (165)	3-Port	4# (2)
8003518	8.0" (203)	1-Port	6# (3)
8003519	8.0" (203)	2-Port	6# (3)
8003520	8.0" (203)	3-Port	6# (3)
8003630*	9.5" (241)	1-Port	8# (4)
8003521	9.5" (241)	2-Port	7# (3)
8003522	9.5" (241)	3-Port	7# (3)
8003621*	12.5" (318)	2-Port	12# (5)
8003620*	12.5" (318)	3-Port	12# (5)

\* Uses Drillable End Plate design with factory sealing washer pockets

### Cable Capacities:

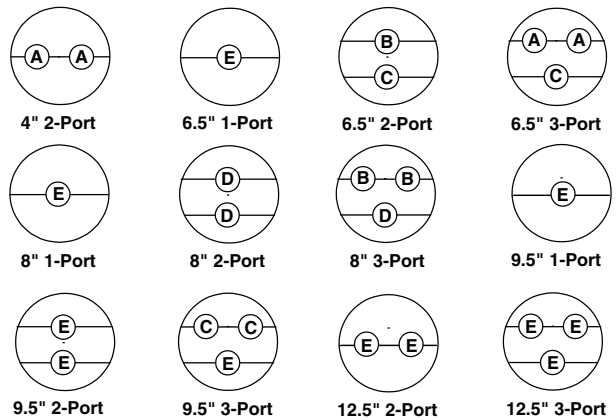

Maximum Cable Diameter (mm)  
 A = 1.0" (25.4)      D = 2.8" (71.1)  
 B = 1.6" (40.6)      E = 3.4" (86.4)  
 C = 2.2" (55.9)

# ARMADILLO® Drillable End Plate Kits

## ARMADILLO Drillable End Plates

These end plates offer a more rugged design that is designed to take on your most demanding environments. They are designed to maintain 15 psi when installed with ARMADILLO Stainless shells and are the choice for vault applications. ARMADILLO Drillable End Plates also feature the LOCK-TAPE™ sealing system which has consistently provided superior cable sealing and pullout strength for more than 20 years.

These end plates are your best option for applications that require field flexibility as they accept almost any size cable and will accommodate a wide variety of cable configurations. Also, any bond connector can be used and fixed sheath opening dimensions do not depend on bond connector placement. However, electric service is needed for the Power End Plate Cutter to field drill the End Plates, and these End Plates cannot be reused.

### Design Features:

The ARMADILLO Drillable End Plates can accommodate a variety of cables, cable sizes and cable configurations and feature two-section and three-section designs. They are available with grounding and air valve inserts for air pressurization, aerial support and grounding through the end plate.

### Interchangeable:

ARMADILLO Drillable End Plates are available in two and three sections designs for use with 4" (102 mm), 6.5" (165 mm), 8.0" (203 mm), 9.5" (241 mm), and 12.5" (318 mm) diameter shell kits.

### Two-Section End Plate

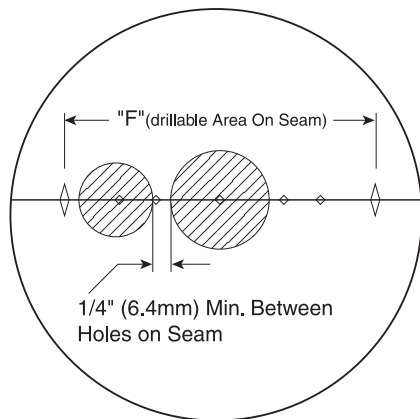

End Plate Size	"F" (mm)
4.0" (102)	2.2" (56)
6.5" (165)	4.1" (104)
8.0" (203)	5.6" (142)
9.5" (241)	7.1" (180)
12.5" (318)	9.3" (236)

### Three-Section End Plate

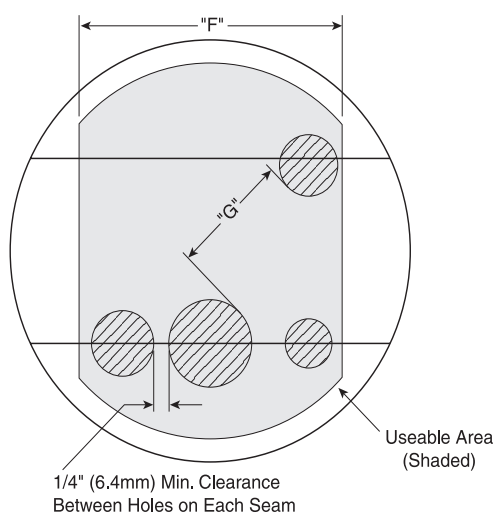

End Plate Size (mm)	Maximum Combined Cable Diameters (mm)			
	1 Cable	2 Cables	3 Cables	4 Cables
4.0" (102)	2.2" (56)	1.95" (50)	1.70" (43)	1.45" (37)
6.5" (165)	4.1" (104)	3.85" (98)	3.60" (91)	3.35" (85)
8.0" (203)	5.6" (142)	5.35" (136)	5.10" (130)	4.85" (123)
9.5" (241)	7.1" (180)	6.85" (174)	6.60" (168)	6.35" (161)
12.5" (318)	9.3" (236)	9.05" (230)	8.80" (224)	8.55" (217)





Minimum distance between holes on opposite seam ("G")

End Plate Size (mm)	G (mm)
6.5" (165)	3/8" (10)
8.0" & 9.5" (203 & 241)	1/2" (13)
12.5" (318)	3/4" (19)







# ARMADILLO® Drillable End Plate Kits

## Two-Section End Plates: One per kit

Size (mm)	Catalog Number				Shipping Weight (kg)
	Inserts				
	None	Ground Only	Air Valve Only	Ground & Air Valve	
					
4.0" (102)	8003539	8003550	8003555	8003560	3# (1)
6.5" (165)	8003540	8003551	8003556	8003561	4# (2)
8.0" (203)	8003541	8003552	8003557	8003562	6# (3)
9.5" (241)	8003542	8003553	8003558	8003563	8# (4)
12.5" (318)	8003284	8003554	8003559	8003564	12# (5)

## Three-Section End Plates: One per kit

Size (mm)	Catalog Number				Shipping Weight (kg)
	Inserts				
	None	Ground Only	Air Valve Only	Ground & Air Valve	
					
6.5" (165)	8000361	8003094	80805422	80805365	4# (2)
8.0" (203)	8003110	8003532	8003137	8003533	6# (3)
9.5" (241)	800081098	8003013	8003121	80805376	8# (4)
12.5" (318)	8003055	8003534	8003122	8003367	12# (5)

# ARMADILLO® Stainless Kits

Kits include top & bottom shell halves, LOCKBAR™ Assemblies, Torque Bars and two 2-section End Plate kits (except 3-section End Plates with 12.5"). Bonding kit (where included) includes shield connectors, pair protectors and bonding braid.

ARMADILLO Stainless Kits with Drillable End Plates			
Catalog Number		Size (mm)	Weight (kg)
With Bonding	Without Bonding		
8000624	8006021	4" x 25" (102 x 635)	15# (6.8)
8006326	8006319	6.5" x 22" (165 x 559)	24# (10.9)
8000626	8006022	6.5" x 28" (165 x 711)	29# (13.2)
8006320	8006261	8" x 28" (203 x 711)	34# (15.4)
8000630	8006023	9.5" x 28" (241 x 711)	41# (18.6)
8006219	8006251	12.5" x 28" (318 x 711)	58# (26.3)
8000634	8006024	6.5" x 38" (165 x 965)	37# (16.8)
8006321	8006262	8" x 38" (203 x 965)	45# (20.4)
8000635	8006025	9.5" x 38" (241 x 965)	51# (23.1)
8006220	8006252	12.5" x 38" (318 x 965)	77# (34.9)
8006322	8006263	8" x 45" (203 x 1143)	50# (22.7)
8006176	8006177	9.5" x 45" (241 x 1143)	59# (26.8)
8006221	8006253	12.5" x 45" (318 x 1143)	84# (38.1)
8006668	8006669	9.5" x 53" (241 x 1346)	66# (29.9)
	8006509**	12.5" x 65" (318 x 1651)	146# (66.2)

\*\*Shell Kit only

\*Shells are welded

ARMADILLO Stainless Filling Flange Kits with Drillable End Plates			
Catalog Number Splice Case with Filling Flange		Size (mm)	Shipping Weight (kg)
With Bonding	Without Bonding		
8006366	8006283	4" x 25" (102 x 635)	15# (6.8)
8006429	8006394	6.5" x 22" (165 x 559)	24# (10.9)
8006367	8006239	6.5" x 28" (165 x 711)	29# (13.2)
8006410	8006395	8" x 28" (203 x 711)	34# (15.4)
8006368	8006240	9.5" x 28" (241 x 711)	41# (18.6)
8006372	8006271	12.5" x 28" (318 x 711)	58# (26.3)
8006369	8006241	6.5" x 38" (165 x 965)	37# (16.8)
8006411	8006396	8" x 38" (203 x 965)	45# (20.4)
8006370	8006242	9.5" x 38" (241 x 965)	51# (23.1)
8006373	8006272	12.5" x 38" (318 x 965)	77# (34.9)
8006412	8006397	8" x 45" (203 x 1143)	50# (22.7)
8006371	8006249	9.5" x 45" (241 x 1143)	59# (26.8)
8006701	8006700	9.5" x 53" (241 x 1346)	66# (22.9)
8006374	8006273	12.5" x 45" (318 x 1143)	84# (38.1)

ARMADILLO Stainless Capacities	
Pair Count of Cables	ARMADILLO Stainless Size (mm)
50 thru 300	4" x 25" (102 x 635)
300 thru 600	6.5" x 22" (165 x 559)
300 thru 1100	6.5" x 28" (165 x 711)
900 thru 1500	6.5" x 38" (165 x 965)
900 thru 2100	8" x 28" (203 x 711)
1200 thru 2400	8" x 38" (203 x 965)
1500 thru 2700	8" x 45" (203 x 1143)
1500 thru 2700	9.5" x 28" (241 x 711)
1800 thru 3600	9.5" x 38" (241 x 965)
2100 thru 4200	9.5" x 45" (241 x 1143)
2100 thru 4200	9.5" x 53" (241 x 1356)
2400 thru 3000	12.5" x 28" (318 x 711)
2700 thru 3600	12.5" x 38" (318 x 965)
3000 thru 4200	12.5" x 45" (318 x 1143)
3000 thru 4800	12.5" x 65" (318 x 1651)

**NOTE:** Capacities based on 24 gauge wire and industry standard splice modules

\*Shells are welded

Recommended RD Encapsulant for ARMADILLO Stainless and REDDI™ Seal Closures	
Size (mm)	Amount (grams)
4" x 25" (102 x 635)	3,800
6.5" x 22" (165 x 559)	8,800
6.5" x 28" (165 x 711)	11,000
6.5" x 38" (165 x 965)	16,000
8" x 28" (203 x 711)	18,000
8" x 38" (203 x 965)	24,000
8" x 45" (203 x 1143)	30,000
9.5" x 28" (241 x 711)	23,000
9.5" x 38" (241 x 965)	33,000
9.5" x 45" (241 x 1143)	41,000
9.5" x 53" (241 x 1346)	46,000
12.5" x 28" (318 x 711)	39,000
12.5" x 38" (318 x 965)	57,000
12.5" x 45" (318 x 1143)	69,000

**NOTE:** Based on 10% of closure volume being occupied by splices.



# ARMADILLO® Series Accessories

## ARMADILLO

### Bonding Kits

The Bonding Kits for the ARMADILLO Closures and ARMADILLO Stainless each contain one long insulated Bonding Braid, three SURE-GRIP™ Shield Connectors, four Pair Protectors and two Short Braids with eyelets (ARMADILLO Closure only).

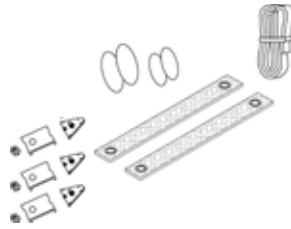

Catalog Number	Description(mm)
8003581	Manhole Bonding Kit for all ARMADILLO Closures

Catalog Number	Description (mm)
80802797	Bonding Kit for 22" & 25" (559 & 635) ARMADILLO Stainless
80802798	Bonding Kit for all 28" (711) ARMADILLO Stainless
80802803	Bonding Kit for all 38" (965) ARMADILLO Stainless
80802802	Bonding Kit for all 45" & 53" (1143 & 1346) ARMADILLO Stainless

### ARMADILLO Coupling

The ARMADILLO Coupling allows the joining of two 6.5" or 9.5" ARMADILLO Stainless shell kits end to end. The result is an increased cable opening area for special applications or for cable repair applications. Any length combination of 6.5" or 9.5" shells may be joined, but it is recommended that no more than two shell kits be joined.



The ARMADILLO Coupling uses the standard torque bars that come with the shell kits to be joined. Pre-cut and punched LOCK-TAPE™ Sealant gaskets are applied to all mating surfaces of the ARMADILLO Coupling halves.

Catalog Number	Description (mm)	Standard Carton Qty.
8003089	6.5" (165) ARMADILLO Coupling Kit	1 Per Carton
8003031	9.5" (241) ARMADILLO Coupling Kit	1 Per Carton

### ARMADILLO Manhole Support

ARMADILLO Manhole Supports are generally used in manhole applications where there is no cable present at one end of the shell or when the cables are inadequate in size for proper support.

- Effective yet inexpensive.
- Made from durable plastic.
- V-Notched for easy application over the shell flange.

**Note:** Tie Wraps are not included. Each kit contains two supports. NOT recommended for filled closures

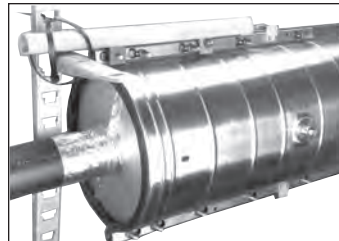

Catalog Number	Description
8003527	Manhole Support Kit for ARMADILLO Stainless Shell Kits

### BUNDLE-LOCK™ Kit

The BUNDLE-LOCK Kit is used to wrap the splice bundle in unfilled closures. The universal kit contains a single, cut-to-size, clear plastic sheet and four cable ties designed for use with any size ARMADILLO Closure, ARMADILLO Stainless shell kit or REDDI™ Seal Closure. The individual sized kits contain 25 BUNDLE-LOCK sheets (no tie wrap) in a single carton.

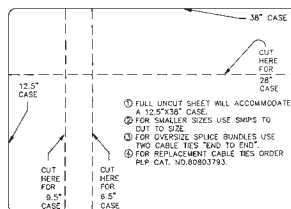

Universal Kit

Catalog Number	Description (quantity in box)
80006264	Universal BUNDLE-LOCK Kit (1)
80807120	BUNDLE-LOCK Kit for 4" x 25" Closures (25)
80807121	BUNDLE-LOCK Kit for 28" Closures (25)
80807122	BUNDLE-LOCK Kit for 38" Closures (25)

# ARMADILLO® Series Accessories

## Cable Sheath Reinforcing Kit

The Cable Sheath Reinforcing Kit is made up of one plastic cable insert and one plastic shim. Both are inserted between the metallic cable shield and the core wrap prior to applying any mechanical telecommunications closure. Cable Sheath Reinforcing Kit provides added integrity under areas that must withstand clamping pressures. The kit comes in two sizes to accommodate a range of cable sizes.



### Features:

- Prevents crimps in the cable sheath
- Protects cable during any closure application
- Can be used with any type of closure

Catalog Number	Range (mm)	Thickness (mm)	Standard Carton Quantity
80009802	2.95" (75) and larger	.062" (2)	10
80004096	2.40" - 2.94" (61- 75)	.062" (2)	10

## Double Sheath Cable Blocking Kit

PREFORMED Double Sheath Cable Blocking Kit is used on double sheath cable in an ARMADILLO Closure or ARMADILLO Stainless case. Kit contains plastic envelopes and sealing tapes for fastening polyurethane resin mold around inner and outer sheaths. Special sealant rings and resin block prevent water from entering and air from escaping between cable sheaths. Application procedure includes instructions for preparing both single and branch cable openings.

Catalog Number	Standard Carton Quantity
8000314	1 Kit

1. Two plastic envelopes
2. Resin kit (dual component)
3. Resin stirring stick
4. Sealant tape
5. Application procedure

## Pressure Wrap Kit

The Pressure Wrap Kit, when used with the REDDI™ Seal, ARMADILLO Stainless forces the encapsulant into the splice and up into the cable core to help prevent moisture penetration and cable pull-out while maintaining electrical continuity. Kit Components:

1. Web liner
2. 1-3/4" sealant tape (8' roll)
3. Cable ties
4. Grounding bar with braid

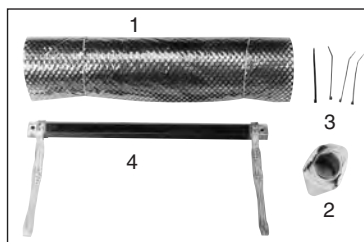

**Note:** Pressure Wrap Stretch Tape not provided.

## ARMADILLO Stainless

Closure Diameter (mm)	Length of Closure		
	Standard (28.4") (721 mm)	Stretch (38.4") (975 mm)	SuperStretch (45.2") (1143 mm)
4.0" (102)	8003032	—	—
6.5" (165)	8003035	8003036	—
8.0" (203)	8003202	8003203	8003204
9.5" (241)	8003037	8003038	8003034
12.5" (318)	8003160	8003161	8003162

## Pressure Wrap Collar

The Pressure Wrap Collar is used with the Pressure Wrap Kit for branch or multi-cable entries. It is not needed for single cable entry applications. One kit is needed for one End Plate. The Pressure Wrap Kit, when used in conjunction with either the REDDI™ Seal or ARMADILLO Stainless, forces the encapsulant into the splice and up into the cable core.



Pressure Wrap Collar (All lengths)	
Catalog Number	Case Diameter (mm)
8003124	6.5" (165)
8003125	9.5" (241)
8003383	12.5" (318)
8003619	8" (203)



# ARMADILLO® Series Installation Materials

## ARMADILLO Sealing Washers

Each sealing washer kit contains four sealing washer halves of the same size, the quantity required for one cable entry port of an ARMADILLO Sealing Washer End Plate.

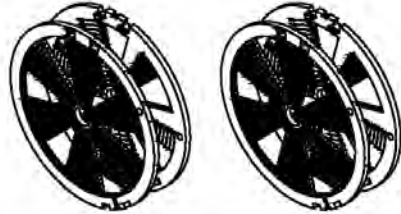

Catalog Number	Description (mm)	Standard Carton Quantity
8003543	1.0" (25) Sealing Washer Kit	25
8003544	1.6" (41) Sealing Washer Kit	25
8003545	2.2" (56) Sealing Washer Kit	25
8003546	2.8" (71) Sealing Washer Kit	25
8003547	3.4" (86) Sealing Washer Kit	25

## Prep Tape

Used to wrap cables (single wrap) in ARMADILLO Sealing Washer End Plates to prepare cable surface for Cable R-Sealant.

**Catalog No. 80806592** (1-1/2" W x 25" L, one roll)

## Cable R-Sealant

Used to seal cables in ARMADILLO Sealing Washer End Plates.

**Catalog No. 80806434** (1-1/2" W x 72" L, one roll)

## End Plate Sealant

Used to seal End Plate sections.

**Catalog No. 8003602** (12" roll)

## LOCK-TAPE™ Sealant for ARMADILLO Drillable End Plates

Catalog Number	Description
80801953	1½"W x 12'L (38mm x 3.6m), one roll
80801954R	2½"W x 12'L (64mm x 3.6m), one roll
80801955R	3W" x 12'L (76mm x 3.6m), one roll
8000375	LOCK-TAPE™ Sealant Kit for 4.0" x 25" (102mm x 635mm) ARMADILLO Stainless
8000376	LOCK-TAPE™ Sealant Kit for 6.5" (165mm) ARMADILLO Stainless
8003118	LOCK-TAPE™ Sealant Kit for 8.0" x 28" (203mm x 711mm), ARMADILLO Stainless
8003119	LOCK-TAPE™ Sealant Kit for 8.0" x 38" & 8.0" x 45" (203mm x 965mm & 203mm x 1143mm) ARMADILLO Stainless
8000377	LOCK-TAPE™ Sealant Kit for 9.5" x 28" (241 x 711mm) ARMADILLO Stainless
8000378	LOCK-TAPE™ Sealant Kit for 9.5" x 38" & 9.5" x 45" (241 x 965mm & 241 x 1143mm) ARMADILLO Stainless
8003120	LOCK-TAPE™ Sealant Kit for 12.5" (318) ARMADILLO Stainless



Sealant kits include the materials shipped with standard ARMADILLO Stainless Shell Kits, one or two rolls of 1-1/2" wide LOCK-TAPE Sealant and the LOCK-TAPE Sealant strips used between End Plate Sections (Two-Section End Plates).

# ARMADILLO® Series Installation Materials/Spare Parts

## ARMADILLO Plug Spool Kit

Used to minimize the amount of R-Sealant required to plug the larger size cable entries in a Sealing Washer End Plate.



Catalog Number	Description (mm)
8003624	Plug Spool for 1.6" (41) or 2.2" (56) Cable Entries. Kit contains six spools
8003625	Plug Spool for 2.8" (71) or 3.4" (86) Cable Entries. Kit contains six spools

## C-Cement

Used to prepare cable for LOCK-TAPE Sealant in ARMADILLO Drillable End Plates.

Catalog Number	Description
80802377	4 oz. Can C-Cement
80805238	1 oz. Tube C-Cement

## Shell Lubricant

Used to coat permanent gaskets in shell halves of ARMADILLO Stainless.

Catalog No.: 80801566 (6 oz. jar)

## LOCKBAR™ Fastening System for ARMADILLO Stainless Shells

Catalog Number	Description (mm)
80802790	LOCKBAR Assemblies for 4.0" x 25" (102 x 635) ARMADILLO Stainless
80804050	LOCKBAR Assemblies for 6.5" x 22" (152 x 559) ARMADILLO Stainless
80802789	LOCKBAR Assemblies for 28" (711) ARMADILLO Stainless
80802791	LOCKBAR Assemblies for 38" (965) ARMADILLO Stainless
80802792	LOCKBAR Assemblies for 45" (1143) Stainless
80805989	LOCKBAR Assemblies for 9.5" x 53" (241 x 1346) ARMADILLO Stainless
80804938	LOCKBAR Assemblies for 12.5" x 65" (318 x 1651) ARMADILLO Stainless
8003025	Replacement stud with nut for 4" ARMADILLO Stainless (1 each)
8003026	Replacement stud with nut for 6.5", 8", 9.5" & 12.5" ARMADILLO (1 each)



# ARMADILLO® Bolt and Torque Bars

## Torque Bars for ARMADILLO Stainless

Catalog Number	Description (mm)
80851245	Torque Bar for 4.0" x 25" (102 x 635) ARMADILLO Stainless, one bar
80803994	Torque Bar for 6.5" x 22" (165 x 559) ARMADILLO Stainless and ARMADILLO Closure, one bar
80850952	Torque Bar for 28" (711) ARMADILLO Closure and ARMADILLO Stainless (6.5", 8.0" & 9.5") (165, 203, 241), one bar
80803788	Torque Bar for 12.5" x 28" (318 x 711) ARMADILLO Stainless, one bar
80850985	Torque Bar for 38" (965) ARMADILLO Closure and ARMADILLO Stainless (6.5", 8.0" & 9.5") (165, 203, 241), one bar
80802591	Torque Bar for 45" (1143) ARMADILLO Stainless (8.0", 9.5" & 12.5") (203, 241, 318), one bar
80805986	Torque Bar for 9.5" x 53" (241 x 1346) ARMADILLO Stainless, one bar
80804935	Torque Bar for 12.5" x 65" (318 x 1651) ARMADILLO Stainless, one bar
80803792	Stiffener Bar for 12.5" x 28" (318 x 711) ARMADILLO Stainless, one bar
80803799	Stiffener Bar for 12.5" x 38" (318 x 965) ARMADILLO Stainless, one bar
80803877	Stiffener Bar for 12.5" x 45" (318 x 1143) ARMADILLO Stainless, one bar
80804937	Stiffener Bar for 12.5" x 65" (318 x 1651) ARMADILLO Stainless, one bar
8003525	Customer Name Plaque Kit (includes one plaque and required fasteners)

# ARMADILLO® Tools

## Socket Tool Kit

Socket Tool Kit contains tools for installing the ARMADILLO Stainless. Standard screwdriver not included.



Catalog Number	Description
80803967	Torque Wrench with Ratchet Head 3/8 Drive
80803968	Ratchet Type Socket Wrench 3/8 Drive
80801150	7/16 Deep Well Socket
80801151	1/2 Deep Well Socket
80803969	6 Extension
8000428	Tool Kit With Torque Wrench in Box
8000420	Tool Kit Without Torque Wrench in Box

## ARMADILLO Sealing Washer Cutter Tool

The ARMADILLO Sealing Washer Cutter Tool is simple to use, made of durable materials and designed specifically for ARMADILLO Sealing Washers.



Catalog Number	Description
8000480	Sealing Washer Cutter Kit, Includes Washer Cutter, Spare Blade & Tote Bag
8000481	Blades for Washer Cutter, 3 Blades

## Power End Plate Cut Kit for ARMADILLO Drillable End Plates

The Power End Plate Cutter comes standard with 26 blades from .375" up to 3.50 in diameter (4 additional blades for larger sizes are available for holes up to 4.00"). It provides a fast and convenient way for cutting through material forming precise cable access holes in the ARMADILLO Drillable End Plates.

The complete Power End Plate Cutter Kit includes:

1. Power End Plate Cutter for use in drilling 3" to 12.5" ARMADILLO Drillable End Plates.
2. Complete blade kit. Includes blades A through Z, drill motor adapter, CABLE Mea-SURE™ Tape, areas for storing other parts and a complete guide for re-ordering parts, all stored in a plastic case.
3. Metal Carrying Case for Power End Plate Cutter and Blade Kit.

Power End Plate Cutter and Accessories		
Catalog Number	Description	Standard Carton Qty.
8000452	Power End Plate Cutter (only)	1 Unit
8000454	Power End Plate Cutter and Case with Blade Kit	1 Kit
8000455	Power End Plate Cutter with Blade Kit	1 Kit
8000468	Power End Plate Cutter Lift Kit	1 Kit
8000445	Carrying Case	1 Unit
8000453	Blade Kit (Blades A-Z)	1 Set
8000417A-DD	Individual Blades (A-DD)	1 Unit
80851659	Electric Drill With Socket	1 Unit
80801944	Drill Motor Adapter (For other than PREFORMED Drill)	1 Unit
80803377	Cutting Blade Adapter	1 Unit



CARRYING CASE



BLADE KIT



POWER END PLATE CUTTER



# ARMADILLO® Tools

## Cable Shaper Tool

The PREFORMED™ Cable Shaper is designed for cable shaping applications encountered in all splicing installations. Adjustable jaws accommodate all cable sizes. The unit is designed to be effectively used in restricted areas to assure proper cable shaping. Coated handles provide a firm gripping surface during use. This tool is ideal for use with all PREFORMED re-enterable closures as well as many other applications requiring shaped cable.

### Features:

- Adjustable jaws accommodate all cable sizes.
- Coated handles for firm gripping.
- Sturdy forged construction.
- Ideal for numerous cable shaping applications.



Catalog No. 8000422

Unique design of the PREFORMED Cable Shaper makes this tool extremely useful for cable shaping during installation of all splice closures.



## End Plate Removal Tool

The End Plate Removal Tool is made of durable galvanized steel. It is specially designed to facilitate End Plate removal from the cable during procedures that necessitate new End Plates, i.e., for use with the ARMADILLO Stainless, REDDI™ Seal, REDDI Closure.

Catalog No. 8000432



# ARMADILLO® Stainless (with Fire Retardant Drillable End Plates)

## ARMADILLO Stainless with Fire Retardant Drillable End Plates

PLP Feature Focus  
©2009 Preformed Line Products

Film available at  
[www.preformed.com](http://www.preformed.com)

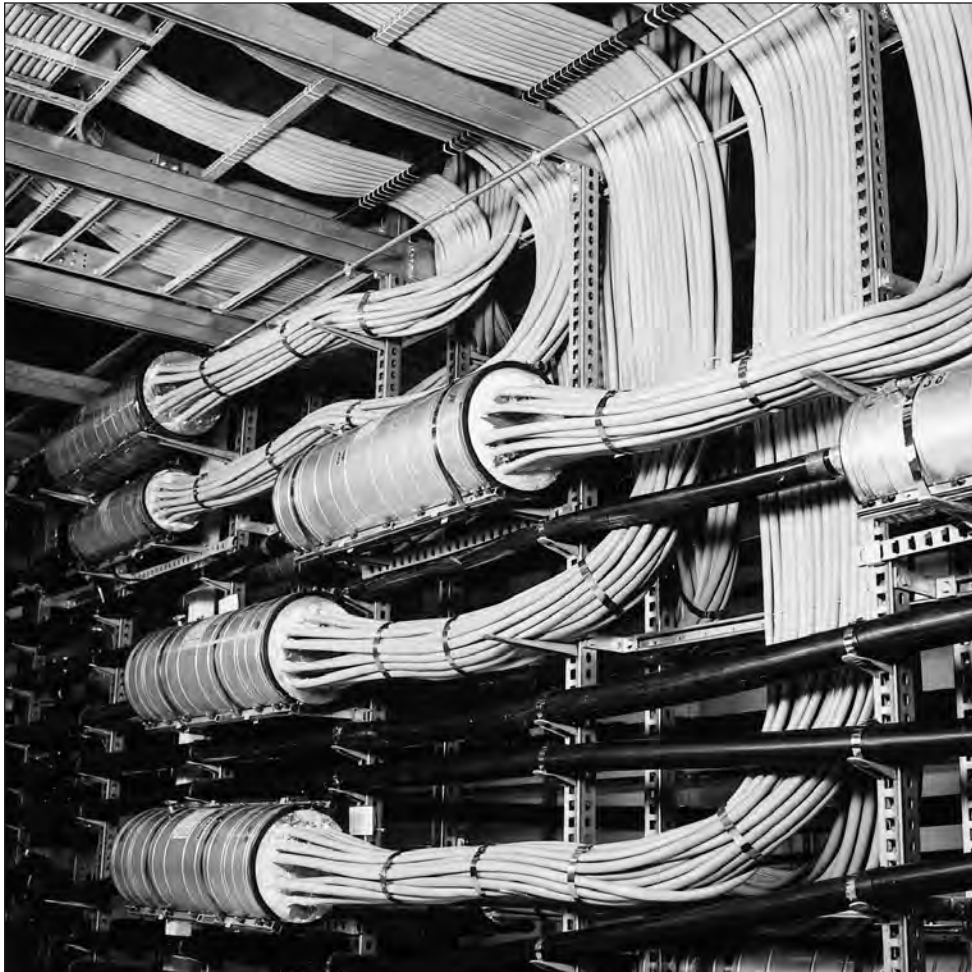

The ARMADILLO Stainless with Fire Retardant Drillable End Plates is a custom system designed to upgrade existing vault closures without disturbing the splices or interrupting the service. This system can also be used for new construction.

Each ARMADILLO Stainless Vault Closure is customized in our factory for the specific splice and shipped in a single carton with the location and closure identification clearly marked.

Simply fill out a PLP Vault Closure Ordering Form for each vault splice. Contact PLP if you need assistance with filling out the form.

Each ARMADILLO Stainless Vault Closure comes with all the materials required for installation and the End Plates have been custom-drilled in our factory which eliminates any field drilling.

The ARMADILLO Stainless Vault Closure System is designed to remain watertight for water depth up to 10 feet. Each closure is also designed to meet or exceed the industry standards for fire retardancy.





# PLP® Vault Closure Ordering Form

Company Name \_\_\_\_\_ Person to contact \_\_\_\_\_

Vault location (or physical address) \_\_\_\_\_

Cable & count \_\_\_\_\_ Contact phone No. \_\_\_\_\_  
(This must be a valid daytime contact number)

Required arrival date \_\_\_\_\_ P.O. No. \_\_\_\_\_

This order form should accompany the Purchase Order to the supplier/distributor.

**IT MUST BE FAXED TO PLP IN CLEVELAND, OHIO AT: 440-442-8816.**

**Your company's MATERIAL CODE #, TONES # or PID #, etc. MUST BE ON THIS ORDER FORM**

Field/Central Office (Circle correct side)	Closure Identification No. _____	Field/Central Office (Circle correct side)

End Plate  
Outside Surface

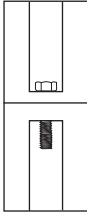

Indicate cable measurement  
at desired hole locations

Check Size Needed

Diameter	Closure Length			
	25"	28"	38"	45"
4"				
6.5"				
8"				
9.5"				
12.5"				

End Plate  
Outside Surface



Indicate cable measurement  
at desired hole locations

\*Splice Case Coupling available for extra long openings

Check and identify if cable sheath is lead

Check and identify if cable sheath is lead

## Vault Closure End Plate Designs (typical\*)

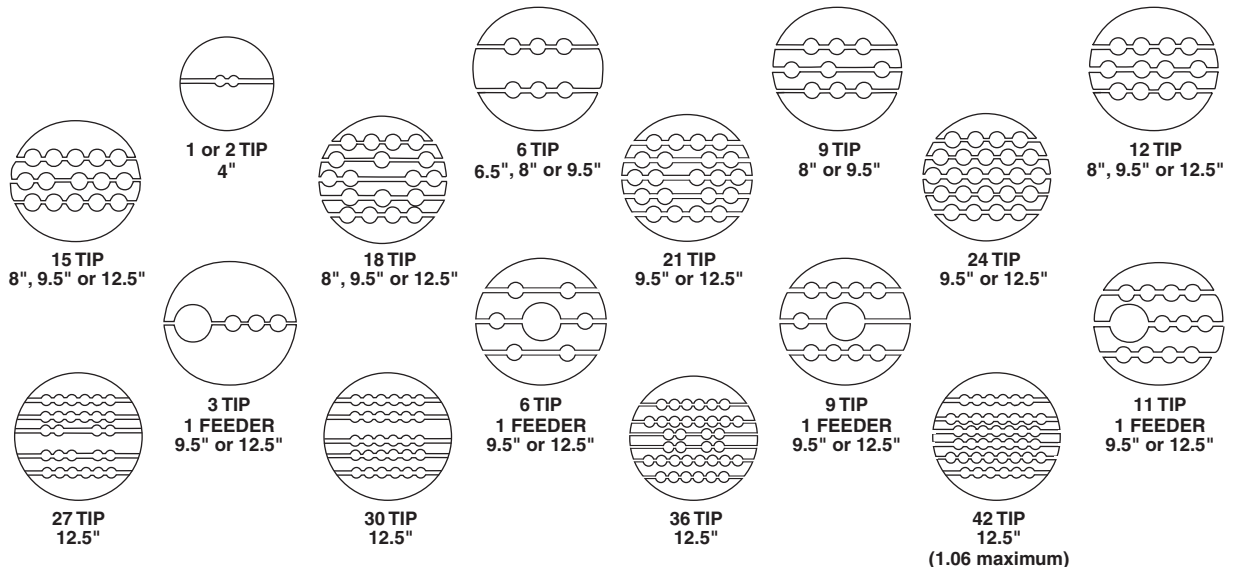

\*NOTE: These are custom-drilled End Plates. Only the most common combinations are shown. Since the End Plates are custom-drilled, almost any combination is possible. Contact PLP for a TIP CABLE MeaSURE™ Tape P/N 02922 at (440) 461-5200.

©2012 Preformed Line Products. All rights reserved.

# ARMADILLO® Stainless for Vault Applications

## Vault Closure End-plate Measuring Procedures

The ARMADILLO Stainless Vault Closure consists of three major components, the Stainless shells and two end plates. One end-plate is utilized for the feeder cable and the other for the tip cables. Each of these components has an associated PLP part number and your company's ordering number (i.e., Material Code, TONE. PID, etc.).

The tip and feeder end-plates must be custom drilled to match the vault splice since a combination of sizes and pair counts are possible. Two measure tapes are required to determine the exact diameter needed for each cable entering the vault splice, a CABLE Mea-SURE™ Tape for the feeder cable and a CABLE Mea-SURE Tape for the central office tip/riser cables. A circumference measure tape may be substituted if either of the recommended tapes is not available. **Note:** any changes in measuring devices must be noted on the order form to insure proper fit of the cables.

The CABLE Mea-SURE tape determines the size of the hole and the number of half-lapped layers of tape to make an air tight seal. This tape is identified by its alpha-numeric markings and index line/with arrow. **Note:** when completing the PLP Vault Closure Ordering Form, the blade size and number of half lapped layers of LOCK-TAPE™ indicated with the CABLE Mea-SURE tape must be indicated at its desired location within the end-plate circles shown on the form. Also, if applicable, one of the vault closure end plate designs shown on the Ordering Form can be referenced by circling the desired end plate design.

**The following specifies the procedures for measuring the cables:**

### Feeder Cables

To obtain this measurement, the tape must be wrapped around the cable at the location where the end plate will be placed. The index line (labeled) must be viewed at a location where the alpha-numeric markings can be readily viewed. At this point the desired measurement may be obtained by wrapping the trailing end of the tape around the cable and recording the alpha/numeric designation that appears at this location. In the event that the index line falls on the line, read in the direction that the arrow points and use that figure as your measurement.

The presence of lead cables must be noted for each end-plate by placing an "x" in the square box shown below each end plate circle on the Ordering Form. Prior to taking the measurements on lead type cable, the lead sheath must be scuffed, 'C' cement applied and allowed to dry, and two half-lapped layers of LOCK-TAPE applied prior to measuring the cable.

### Tip Cables

The tip CABLE Mea-SURE tape is designed to allow for the proper sealing of the space around the tip cables utilizing a silicone sealant. The closure may be pressurized to 5 psi if the tip cables have been properly measured and the silicone sealant has cured.

The tip cable procedure is similar to the feeder cable measuring procedure with the exception of the type of CABLE Mea-SURE Tape being used. The tip cable tape is in numeric form.

To obtain this measurement, place the CABLE Mea-SURE tape on the cable with the index line (labeled) in a position on the cable that can be readily viewed. Wrap the trailing end of the tape around the cable, lining up the numeric designation with the index line. This is the size of the tip cable.

In the event that the index line falls on a line between the numbers, read in the direction of arrow and select that measurement.

**NOTE:** Always measure several of the tip cables and average the readings if they vary less than three divisions. For example, if the measurements are, one cable measures 6, another one measures 7 and another one measures 8 and these figures are consistent on all cables, then it is reasonable to consider the average to be a number 7 for all tip cables. The averaging requirement is necessary due to the manufacturers design tolerances.



# ARMADILLO® Stainless (with Urethane End Plates for Vaults)

## ARMADILLO Stainless for New Construction in Vaults

For new construction in vaults a 21-hole urethane End Plate is available to provide the required fire resistance. The end plate will accommodate tip cables ranging from 0.88" to 1.06" in diameter. End Plate Plugs are available to seal unused holes.

Fire Retardant Closure Kits and Parts		
Catalog Number	Description (mm)	Standard Carton Quantity
*	Fire Retardant Closure Replacement Kits to include a PREFORMED Splice Case, Fire Retardant feeder cable End Plate and Four-Section or Six-Section End Plate.	1 Kit
8003053	12.5" (318) PREFORMED Two-section Fire Retardant End Plate. For Fire Retardant Closure application only.	1 Kit
8003033	Flame Retardant Tape Kit, 1-1/2" wide x 9 yards (38 x 8230)	1 Kit

\*These are customized Fire Retardant Closure Replacement Kits with End Plates that are pre-drilled at the factory. The catalog numbers are also specially formulated to completely describe each custom order. Consult with your local PREFORMED representative, distributor or contact the factory directly for more information.

**Note:** For 12.5" requirements, consult the factory.

# RD™ Encapsulant/Resin Kits for Buried Applications

## Re-Enterable

Preformed Line Products RD Encapsulant is a two-component polyurethane compound providing excellent moisture and electrical insulation protection for telecommunications cable splices.

RD Encapsulant offers numerous features and benefits, including:

- Easy to mix and pour
- Fast setting
- Room temperature curing
- Excellent splice penetration
- Easy to re-enter
- Bonds to itself when closures are refilled
- High impact strength, low water absorption
- Superior hydrolytic stability
- Low weight loss, nonexpanding
- High volume resistivity
- Minimal exotherm
- Contains no TDI or MOCA

Recommended RD Encapsulant for ARMADILLO® Stainless, and REDDI™ Seal Closures	
Size	Amount
4" x 25" (102 x 635)	3,800
6.5" x 22" (165 x 559)	8,800
6.5" x 28" (165 x 711)	11,000
6.5" x 38" (165 x 965)	16,000
8" x 28" (203 x 711)	18,000
8" x 38" (203 x 965)	24,000
8" x 45" (203 x 1143)	30,000
9.5" x 28" (241 x 711)	23,000
9.5" x 38" (241 x 965)	33,000
9.5" x 45" (241 x 1143)	41,000
9.5" x 53" (241 x 1346)	46,000
12.5" x 28" (318 x 711)	39,000
12.5" x 38" (318 x 965)	57,000
12.5" x 45" (318 x 1143)	69,000

**Note:** Based on 10% of closure volume being occupied by splices.

Packaging (standard can kits)				
Catalog Number	Nominal Kit Net Wt. (grams)	Part A (polyol) Can size	Part B (pre-polymer) Can size	Kits Per Carton
80802437	600	1 qt.	½ pt.	12
80802820	750	1 qt.	½ pt.	12
80802438	1200	½ gal.	½ pt.	6
80802821	1500	½ gal.	1 pt.	6
80802822	2600	1 gal.	1 pt.	4
80802439	3000	1 gal.	1 pt.	4
80802823	6000	2½ gal. pail	1 qt.	1
80802440	7800	2½ gal. pail	½ gal.	1
80802826	8000	2½ gal. pail	½ gal.	1



# Spacer Mat/Re-Encapsulation Kits for Buried Applications

## Non Re-Enterable

The PREFORMED™ Polyurethane Resin Kit offers these outstanding distinctive features:

- Comes in three sizes for most economical usage
- Use of cans allows longer shelf life and “one mix—one pour” application
- Excellent electrical properties
- Low exotherm
- Low viscosity
- Easy to mix
- Good working life with short cure time
- Hard set in 15-20 minutes
- Resilient and tough
- Shelf life 18 months
- Meets OSHA specifications, contains no MDA, MOCA, or TDI
- Adhesion promoters are available upon request



Packaging (Standard Can Kits)		
Catalog Number	Description	Standard Carton Qty.
8000310	Resin Kit 8 oz. (227grams) kit	1 Kit
8000311	Resin Kit 15 oz. (425 grams) kit	1 Kit
8000312	Resin Kit 33 oz. (936 grams) kit	1 Kit

## Spacer Mat

PREFORMED Spacer Mat is an open-cell, polyurethane foam material ideal for splice closures using solid-cast polyurethane resin as an encapsulant. The spacer is used to maintain at least 1/4" of the resin around the splice. Spacer Mat can be also used to wipe excess grease off cable pairs prior to splicing filled cable.

Open-cell Polyurethane Foam		
Catalog Number	Description	Standard Carton Qty.
8000657	2½" x ¼" x 80" (318 x 6 x 2032)	50 units
8000653	4" x ¼" x 80" (102 x 6 x 2032)	50 units
8000658	18" x ¼" x 80" (457 x 6 x 2032)	10 units



## Re-encapsulation Kit

The Re-encapsulation Kit includes a check valve and funnel with tubing which allows for refilling and filling flange stainless steel closures.

Catalog No.: 8003105

