

COYOTE® MPC (Multi-Purpose Closure)

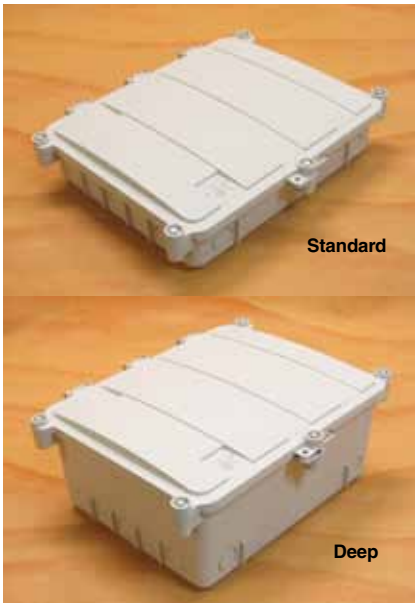

The COYOTE MPC is constructed of durable, UV stabilized, flame retardant (UL 94-5VA) polymer to permit interior or exterior applications. Eight cable entrance ports around the exterior accept an easy-to-use grommet system and standard commercially available fittings. The closure's interior can be configured to address slack storage, splicing, cross-connect, hardened adapter applications or any combination. Pre-terminated configurations are also available to minimize the amount of labor required during installation.

Key Features:

- 8 Cable entrance ports around closure exterior
- Cable entrance ports accepts PLP grommet adapters or commercially available fittings
- Easy to use grommet system – 7 different multi and single hole grommets to choose from
- Constructed with UL 94 5VA polymer compounds, to provide the highest flame resistant rating
- Interior grid hole pattern allows custom organization of various components
- Integrated rubber seal designed to eliminate water entry
- Custom logo plaques available to identify your company logo – contact your PLP representative for further details
- Offers NEMA4 performance
- Tested in accordance to elements of the Telcordia GR-771-CORE specification

OptiTap™ is a registered trademark of Corning Cable Systems.

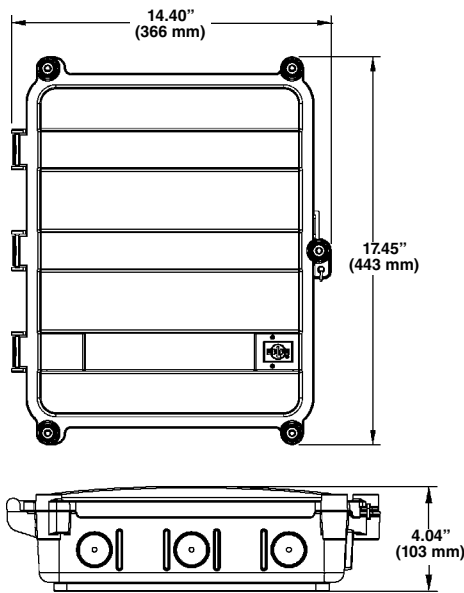

COYOTE Standard MPC

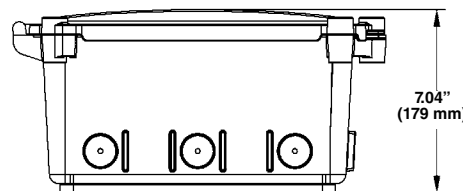

COYOTE Deep MPC



COYOTE MPC



COYOTE MPC for OptiTap™ Applications



COYOTE MPC for Cross-Connect Applications



4 Hole Grommet Port Adapter Kit





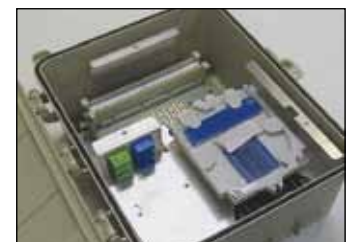







Grommet Port Adapter



Custom Design Applications

COYOTE Standard MPC Kits	
Catalog No.	Description
COYMP-000	COYOTE Standard MPC (EMPTY)
COYMP-001	COYOTE Standard MPC with (1) 4-Hole Grommet Port Adapter Kit (P/N:8003812) and (1) Organizer Clip Kit (P/N:8003813)
COYMP-002	COYOTE Standard MPC with OptiTap™ Adapters - Includes (1) Bulkhead with 2 OptiTap Adapters, (1) 4-Hole Grommet Port Adapter Kit (P/N: 8003812), (1) 8-Hole Grommet Port Adapter Kit (P/N: 8003818), (1) Organizer Clip Kit (P/N: 8003813), (1) Storage Bracket Kit (P/N: 8003811), and (1) Grommet Port Adapter Shroud (P/N: 80808467)
COYMP-003	COYOTE Standard MPC with Step Grommets - Includes (1) Step Grommet Kit (P/N: 80808618) and (1) Organizer Clip Kit (P/N: 8003813)
COYMP-004	COYOTE Standard MPC with Splice Tray and Grommets - Includes (1) 4-Hole Grommet Port Adapter Kit (P/N:8003812), (1) 2-Hole Grommet Port Adapter Kit (P/N: 8003828), (2) Organizer Clip Kits (P/N: 8003813), (2) Cable Restraint Brackets (P/N: 8003829), (2) Tray Brackets (P/N: 80808689), and (1) Standard Short Splice Tray -12 splice count (P/N: 80806033)
COYMP-005	COYOTE Standard MPC with Bulkhead and Tray Supports - Includes (2) 6 Port SM, SC/UPC Adapter Plates (P/N: 7500367), (3) 4-Hole Grommet Port Adapter Kit (P/N:8003812), (2) Organizer Clip Kits (P/N: 8003813), (1) 1-Hole Grommet Port Adapter Kit (P/N: 8003827), and (4) Cable Restraint Brackets (P/N: 8003829)
COYMP-006	COYOTE Standard MPC with LITE-GRIP® Tray and Tray Supports - Includes (2) Organizer Clip Kits (P/N: 8003813), (1) 1-Hole Grommet Port Adapter Kit (P/N: 8003827), (1) Cable Restraint Brackets (P/N: 8003829), (1) LITE-GRIP Short Splice Tray - 16 splice count (P/N: 80808392), and (1) Splice Tray Support Kit (P/N: 80808853)
COYMP-008	COYOTE Standard MPC with (2) Organizer Clip Kits (P/N: 8003813) and (4) 2-Hole Grommet Port Adapter Kits (P/N: 8003828)

COYOTE® MPC (Multi-Purpose Closure)

COYOTE MPC Accessories		
Catalog No.	Description	Accessory
8003813	Organizer Clip Kit for Standard or Deep MPC - contains 3 clips	
8003870	Dual Organizer Clip Kit for Deep MPC - contains 3 clips (Deep MPC Only)	
8003811	Storage Bracket Kit - contains 2 brackets	
8003879	Tray Bracket Kit for either Standard MPC or Deep MPC - contains (2) tray brackets, (2) studs, (1) hold down strap, (4) nylon cable clamps, and (1) felt strip	
8003829	Cable Restraint Bracket Kit - contains 1 restraint bracket	
80808467	Raceway Shroud Kit - contains 1 shroud	
80808508	2 Port Internal OptiTap™ Bracket Kit - includes adapters	
8003824	8 Port Internal OptiTap Bracket Kit - does not include adapters	
80808916	Empty Bulkhead Kit for Standard or Deep MPC - Accepts 2 Adapter Modules	
80808960	Empty Bulkhead Kit for Deep MPC ONLY - Accepts 4 Adapter Modules	

NOTE: For other COYOTE MPC Cross-Connect Accessories, refer to the COYOTE Passive Optical Components & PLC Splitters Modules Section on page 23. OptiTap™ is a registered Trademark of Corning Cable Systems.

COYOTE Deep MPC Kits	
Catalog No.	Description
COYMPC-D000	COYOTE Deep MPC (EMPTY)
COYMPC-D001	COYOTE Deep MPC with (1) 4-Hole Grommet Port Adapter Kit (P/N:8003812), (1) Cable Restraint Bracket (P/N: 8003829), and (2) Dual Organizer Clip Kits (P/N:8003870)

COYOTE MPC Grommet Port Adapter Kits						
Catalog No.	Cable Range	Description	Accessory			
8003825	.825" - 1" (21 mm - 25 mm)	1 Hole Grommet Port Adapter				
8003826	.60" - .825" (15 mm - 21 mm)	1 Hole Grommet Port Adapter				
8003827	.40" - .60" (10 mm - 15 mm)	1 Hole Grommet Port Adapter				
8003828	.275" - .500" (7 mm - 12 mm)	2 Hole Grommet Port Adapter				
8003812	.120" - .275" (3 mm - 7 mm)	4 Hole Grommet Port Adapter				
8003818	.120" - .200" (3 mm - 5 mm)	8 Hole Grommet Port Adapter				
80808618	.070" - 1.00" (1.8 mm - 25 mm)	Stepped Grommet Kit				
	Splice Tray 12ct Standard Profile (Single Fusion)	LITE-GRIP® Short Tray 24ct Low Profile (Single Fusion)	144ct Deep Profile LITE-GRIP® Short Tray (Single Fusion/ Double Stack)			
						
Catalog No.	80806033	80809958	80808945			
COYOTE MPC Type	Tray Count	Splice Count	Tray Count	Splice Count	Tray Count	Splice Count
Standard MPC	3	36	4	96	2	80
Deep MPC	8	96	12	288	6	240



MPC Mounted to House

MPC

- Indoor Use
- Outdoor Use
- Pole/Wall Mount
- Below Grade
- Direct Buried
- Flame Retardant

Multi-Purpose Closure