

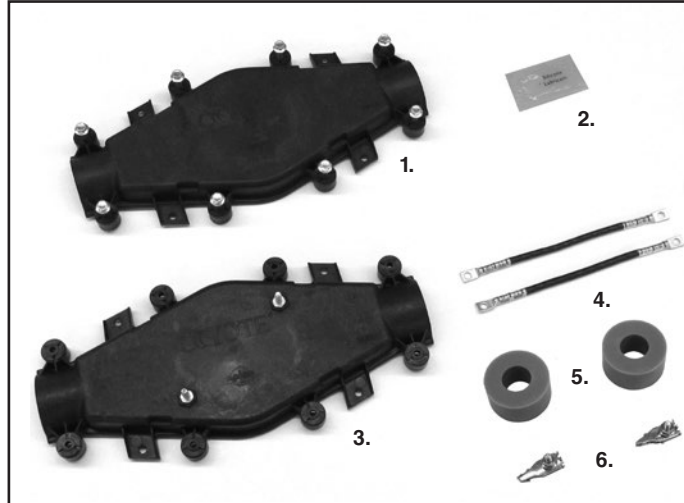

COYOTE® BGC (Bonding and Grounding Closure)

Be sure to read and completely understand this procedure before applying product. Be sure to select the proper PREFORMED™ product before application.



NOMENCLATURE:

1. Cover (1)
2. Silicone Lubricant (1 five gram packet)
3. Base (1)
4. Bonding Harnesses (2)
5. Grommets, any size (2)
6. Bond Connectors (2)

Catalog Number	PLP PN	COYOTE® BGC Closure Kit Options for OSP Applications
COYBGC-001	800014869	Supports cable diameter range of .40" - .60" (10.7 mm – 15.2 mm)
COYBGC-002	800014870	Supports cable diameter range of .60" - .85" (15.2 mm – 21.6 mm)
COYBGC-003	800014871	Supports cable diameter range of .85" - .96" (21.6 mm – 24.4 mm)
Catalog Number	PLP PN	COYOTE® BGC Closure Kit Options for Vault Applications (Flame Retardant)
COYBGCFR-001	800014872	Supports cable diameter range of .40" - .60" (10.7 mm – 15.2 mm)
COYBGCFR-002	800014873	Supports cable diameter range of .60" - .85" (15.2 mm – 21.6 mm)
COYBGCFR-003	800014874	Supports cable diameter range of .85" - .96" (21.6 mm – 24.4 mm)
Catalog Number	PLP PN	Mounting Bracket Kits
8003832	8003832	Aerial Mounting Bracket – Strand Applications
8003835	8003835	Hand Hole Mounting Bracket
8003830	8003830	Pole/Wall Mount Bracket
All kits contain: Closure shells w/(2) grounding studs, (2) grommets, (2) bond harnesses, and (2) bond connectors		

STEP #1 Remove cover from base.

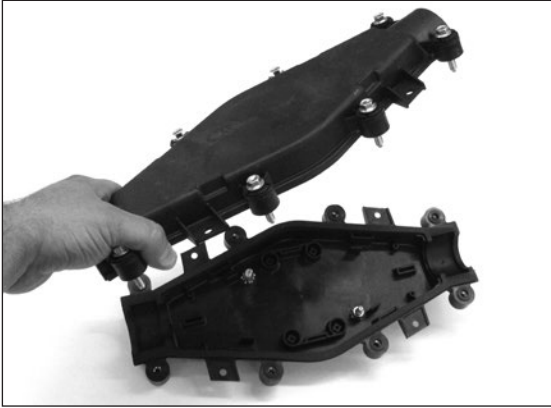

STEP #2 Remove the cable sheath and armor from the cable as shown below.

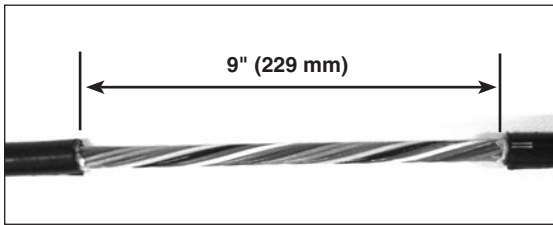

STEP #3 Install a shield connector at each sheath opening location and bond per your accepted company practice.

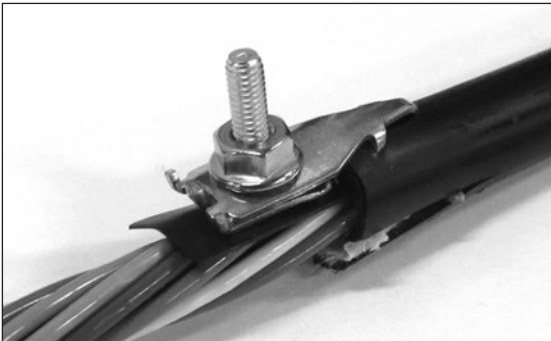

STEP #4 Measure the cable to determine the diameter and select the proper grommet kit for your application.



STEP #5 Install a grommet on each end of the cable as shown below.



STEP #6 Apply a thin layer of silicone lubricant to the outer surface of each grommet. Spread the lubricant evenly around the grommet with your finger.

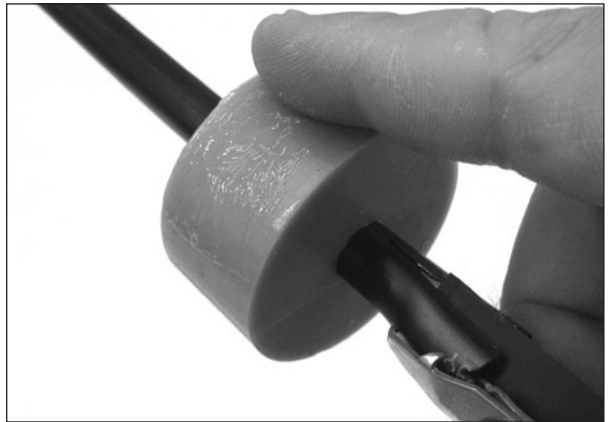
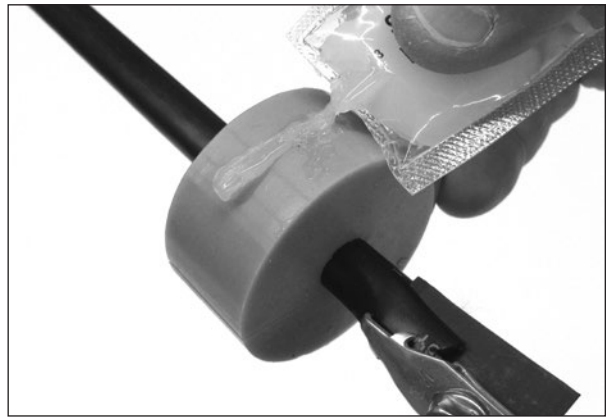

PLP Tip: The base of closure contains ground studs. If desired, prepare your work surface using the drilling template shown on page 7 to keep the base stable during assembly.

STEP #7 Insert the cable assembly into the base as shown below. Make sure that the slit of each grommet is facing upward when installed into the base of the closure.

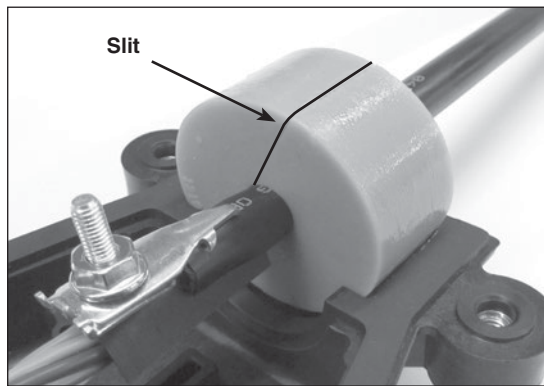
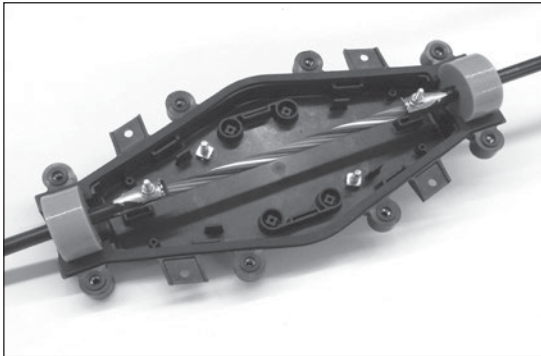

STEP #9 Apply a thin layer of silicone lubricant to all sealing surfaces of the base and the cover.

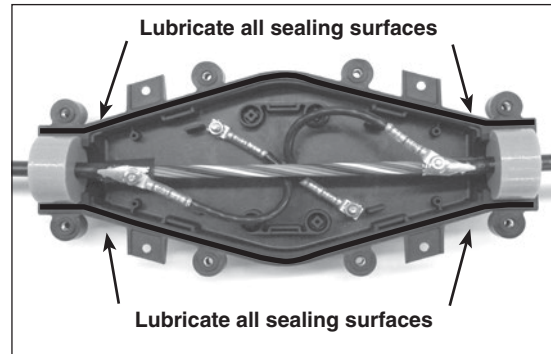

STEP #10 Secure the cover to the base by evenly hand-tightening the (8) cover bolts with a 3/8" driver until the cover is fully seated onto base.

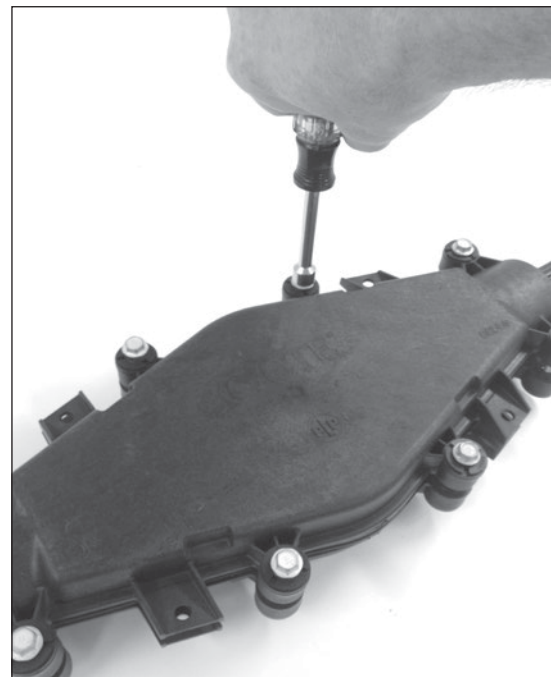

STEP #8 Attach one end of each bonding harness to a shield connector and the other end of each bonding harness to a ground stud as shown below.

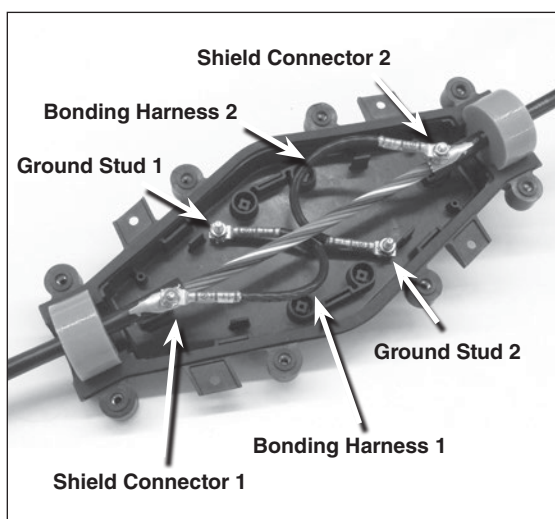

STEP #11 Make sure that the cover and base surfaces are touching when verifying that the cover is fully seated on the base.

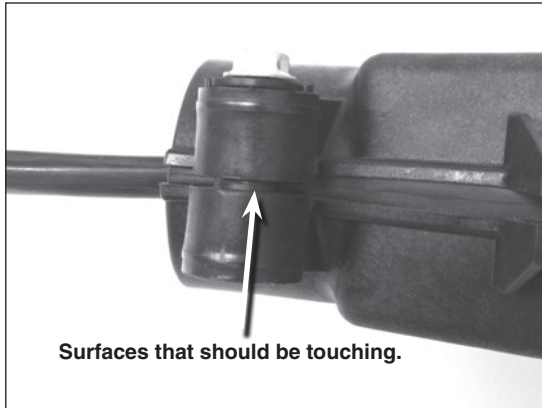

MOUNTING OPTIONS

STEP #12a Pole/Wall Mount – Strapped Applications (Bracket Kit P.N.: 8003830)
Loop the strap through the slots of the bracket as shown below.

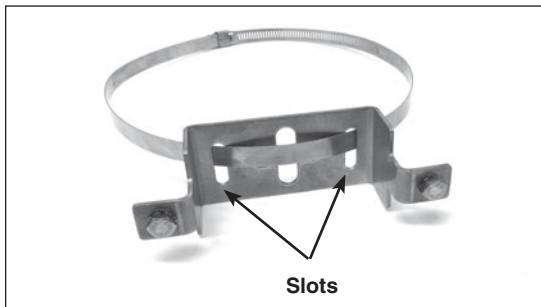

STEP #12b Pole/Wall Mount – Bolted Applications (Bracket Kit P.N.: 8003830)
Secure the brackets to the pole with bolts as shown below.

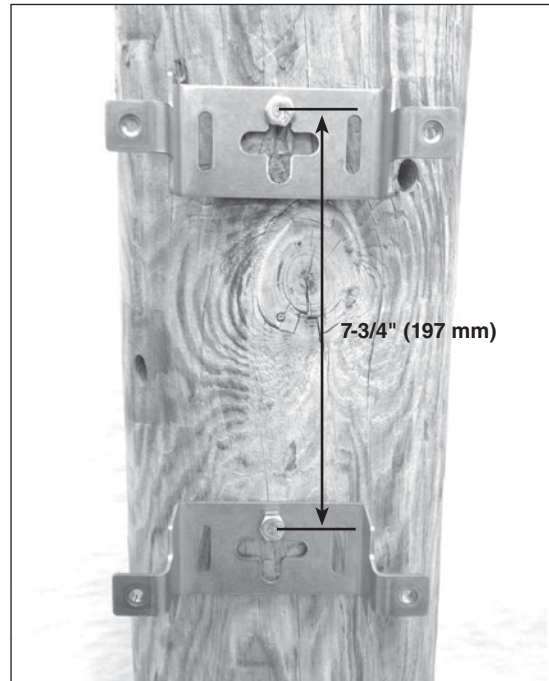

STEP #12c Pole/Wall Mount – Strapped or Bolted Applications (Bracket Kit P.N.: 8003830)
Insert the bolts through the tabs of the base and secure to the mounting bracket. Once the base is secured to the bracket, attach the cover to the base.

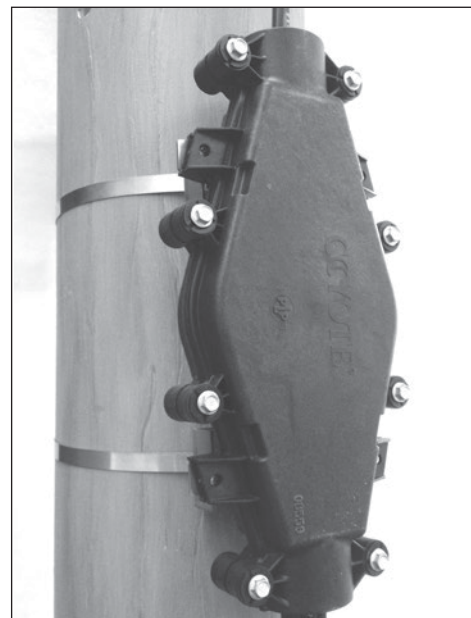

STEP #13a COYOTE® Universal Mounting Hanger Bracket for Aerial Applications.

(Strand Mount Bracket Kit – P.N.: 8003832)

(ADSS Mount Bracket Kit – P.N.: 8003852)

Secure the hanger brackets to the outside of the tabs of the base with the nuts and bolts provided in the kit.

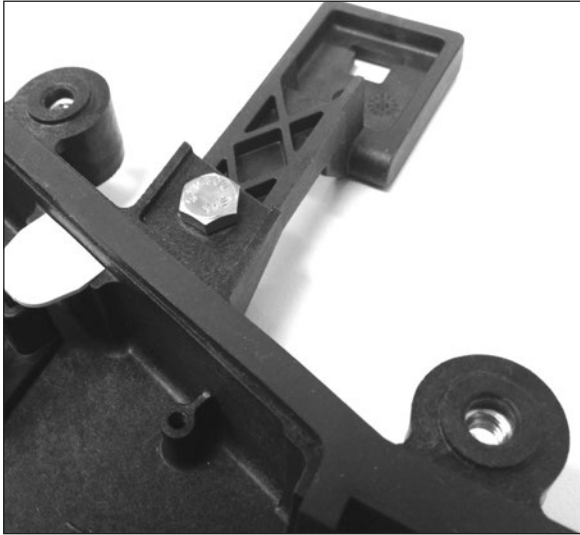

STEP #13b COYOTE® Universal Mounting Hanger Bracket for Aerial Applications.

(Strand Mount Bracket Kit – P.N.: 8003832)

(ADSS Mount Bracket Kit – P.N.: 8003852)

Secure the cover to the base by evenly hand-tightening the (8) cover bolts with a 3/8" driver until cover is fully seated onto base.



STEP #13c COYOTE® Universal Mounting Hanger Bracket for Aerial Applications.

(Strand Mount Bracket Kit – P.N.: 8003832)

(ADSS Mount Bracket Kit – P.N.: 8003852)

For strand applications, secure the closure to the strand with the bug nuts. For ADSS applications, secure the closure to the ADSS dead-end with ADSS clamps.

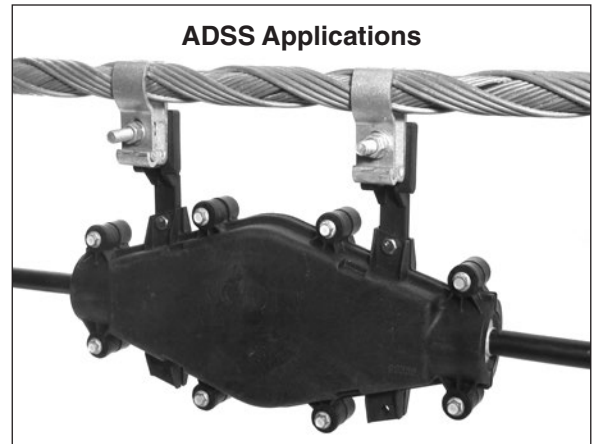
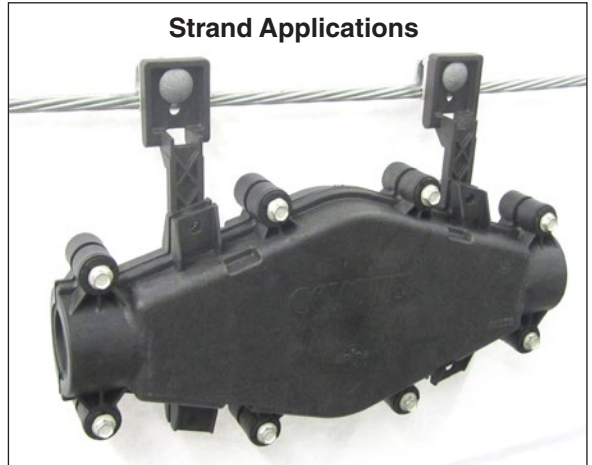

STEP #14a COYOTE® Universal Mounting Hanger Bracket for Hand Hole Applications.
(Hand Hole Mounting Bracket Kit – P.N.: 8003835)

Secure the hanger brackets to the outside of the tabs of the base with the nuts and bolts provided in the kit.

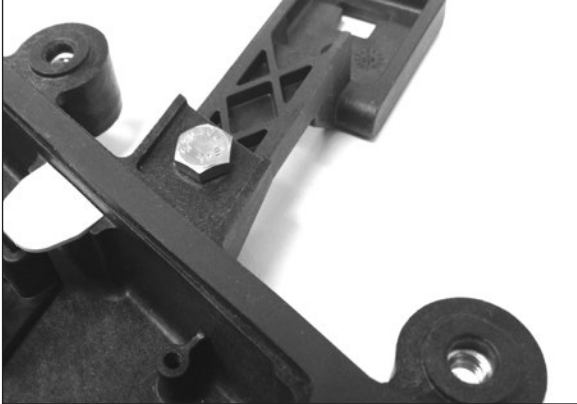

STEP #14c COYOTE® Universal Mounting Hanger Bracket for Hand Hole Applications.
(Hand Hole Mounting Bracket Kit – P.N.: 8003835)

Secure the Universal Mounting Bracket to the inner wall of the hand hole using the 2 screws provided.



STEP #14b COYOTE® Universal Mounting Hanger Bracket for Hand Hole Applications.
(Hand Hole Mounting Bracket Kit – P.N.: 8003835)

Secure the cover to the base by evenly hand-tightening the (8) cover bolts with a 3/8" driver until cover is fully seated onto base.



STEP #14d COYOTE® Universal Mounting Hanger Bracket for Hand Hole Applications.
(Hand Hole Mounting Bracket Kit – P.N.: 8003835)

Slide the hanger brackets into the proper slots of the Universal Mounting Bracket and snap the hinged lid into place to secure the hanger brackets.

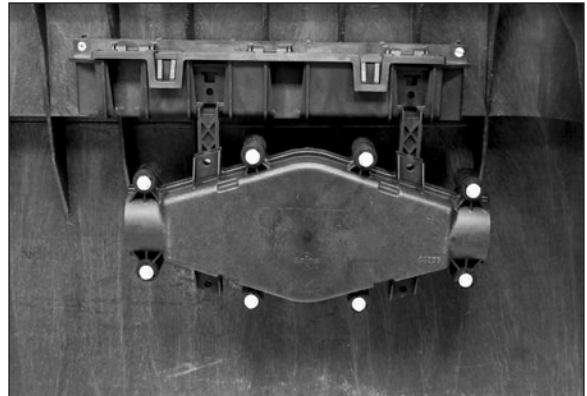

WORK SURFACE DRILL TEMPLATE

Prepare work surface, if desired. Holes provide clearance for ground studs in closure base.

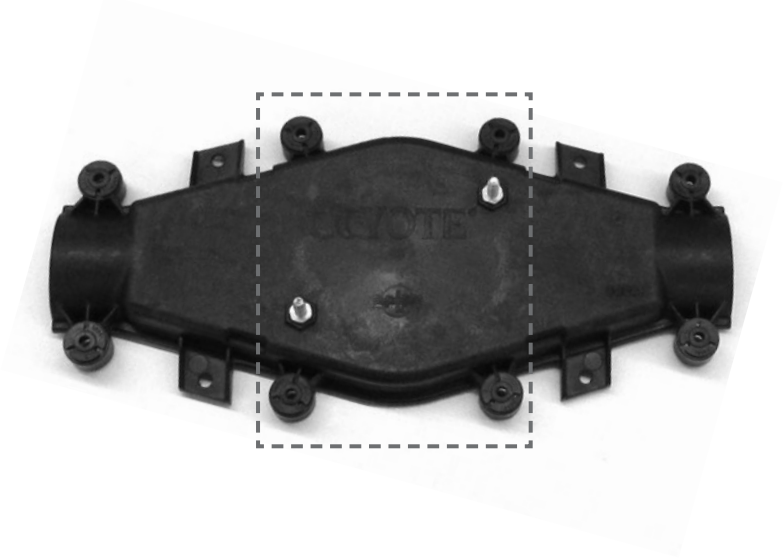
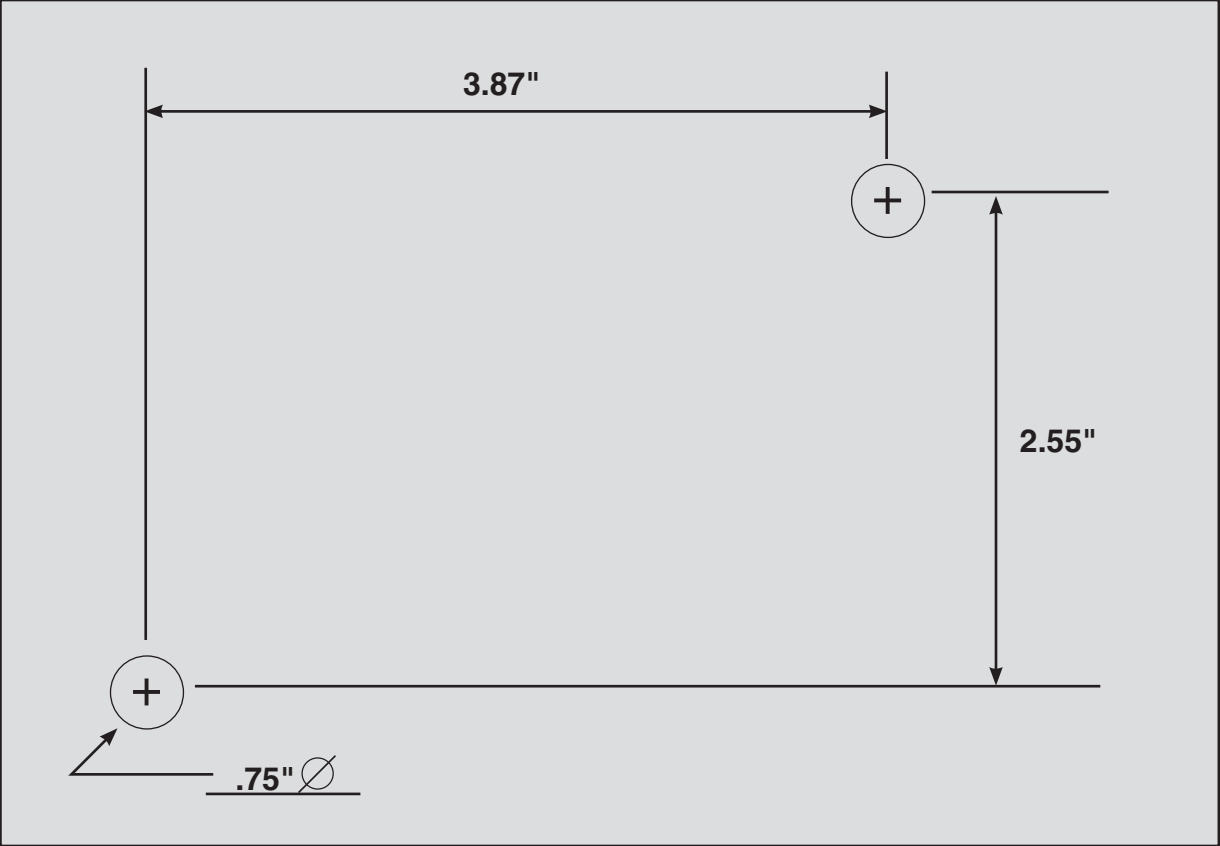

SAFETY CONSIDERATIONS

This application procedure is not intended to supersede any company construction or safety standards. This procedure is offered only to illustrate safe application for the individual. **FAILURE TO FOLLOW THESE PROCEDURES MAY RESULT IN PERSONAL INJURY OR DEATH.**

Do not modify this product under any circumstances.

This product is intended for use by trained technicians only. **This product should not be used by anyone who is not familiar with, and not trained to use it.**

When working in the area of energized lines, extra care should be taken to prevent accidental electrical contact.

For proper performance and personal safety, be sure to select the proper size PREFORMED™ product before application.

PREFORMED products are precision devices. To insure proper performance, they should be stored in cartons under cover and handled carefully.



PREFORMED LINE PRODUCTS

P.O. Box 91129, Cleveland, Ohio 44101 • 440.461.5200 • www.preformed.com • e-mail: inquiries@preformed.com

SP3252